

---

# KODAK EASYSHARE LS443 Zoom Digital Camera



## User's Guide

Visit Kodak on the World Wide Web at [www.kodak.com](http://www.kodak.com)



Eastman Kodak Company

343 State Street

Rochester, New York 14650

© Eastman Kodak Company, 2002

Kodak and EasyShare are trademarks of Eastman Kodak Company.

P/N 6B8176

## Front View

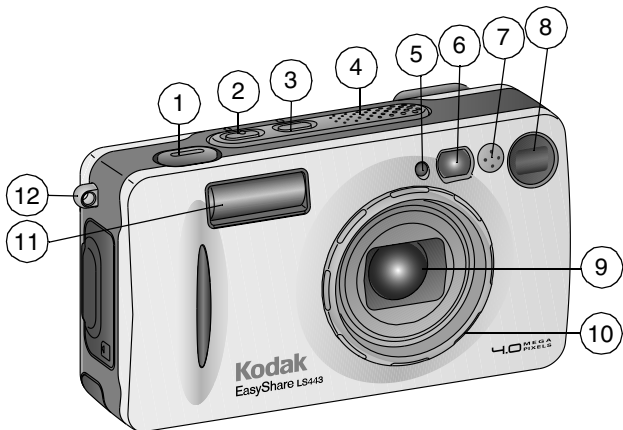

1 Shutter button

2 Flash button

3 Self Timer/Burst button

4 Speaker

5 Light sensor

6 Low Light Auto Focus/Self timer LED

7 Microphone

8 Viewfinder

9 Lens

10 Lens thread ring

11 Flash unit

12 Wrist strap post

## Back View

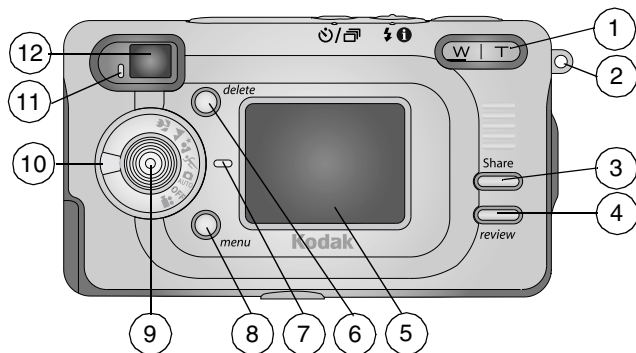

- |                                   |                      |
|-----------------------------------|----------------------|
| 1 Zoom (Wide Angle and Telephoto) | 7 Power light        |
| 2 Wrist strap post                | 8 Menu button        |
| 3 Share button                    | 9 Joystick/OK button |
|                                   | ◀/▶ ▲/▼/press        |
| 4 Review button                   | 10 Mode dial         |
| 5 LCD (picture, video display)    | 11 Ready light       |
| 6 Delete button                   | 12 Viewfinder        |



## Side Views

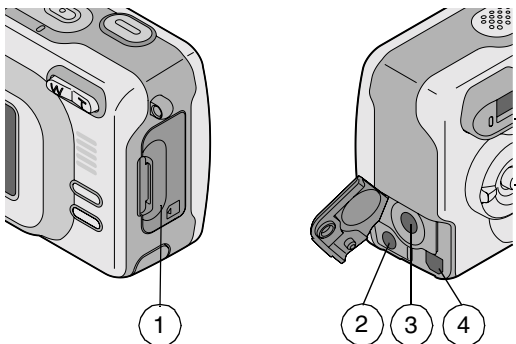

1 Slot for optional MMC/SD card

2 A/V Out

3 DC In

4 USB port

## Bottom View

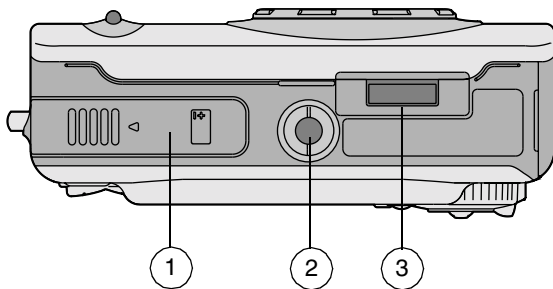

- 1 Battery door
- 2 Tripod socket
- 3 Dock connector

---

# Table of Contents

1	Getting Started .....	1
	Install Software First.....	1
	Need This Guide in Larger Print?.....	1
	What Can I Do With My Camera?.....	2
	What Can I Do With My Digital Pictures and Videos? .....	2
	Package Contents.....	3
	Attaching the Wrist Strap.....	4
	Loading the Battery.....	5
	Using the AC Adapter .....	5
	Mode Dial Settings.....	6
	Turning On the Camera.....	7
	Setting the Date and Time .....	8
	Checking Camera Status Bar .....	9
	Inserting an MMC/SD Card.....	10
	Choosing Internal Memory or MMC/SD Card.....	11
	Adding Optional Lenses .....	12
2	Taking Pictures .....	13
	Taking Pictures in Auto Mode.....	13
	Using the Low Light Auto Focus LED .....	14
	Taking Pictures in Sport Mode .....	14
	Taking Pictures in Night Mode .....	15
	Taking Pictures in Landscape Mode.....	16
	Taking Pictures in Close-up Mode .....	17

Liveview—Using the LCD to Frame Your Subject .....	18
Quickview—Reviewing the Picture Just Taken .....	19
Using the Auto Focus Framing Marks .....	20
Using the Optical Zoom.....	21
Using the Advanced Digital Zoom.....	21
Using the Flash.....	22
Putting Yourself in the Picture.....	24
Taking a Burst Series of Pictures .....	25
Still Menus .....	26
Setting Exposure Compensation .....	27
Setting White Balance .....	28
Setting Picture Quality.....	29
Setting Color Mode .....	30
Setting Exposure Metering .....	31
Setting Focus Zone.....	32
Setting ISO Speed.....	33
Setting Long Time Exposure.....	34
Placing the Date on Pictures .....	35
Setting the Orientation Sensor.....	36
Other Features.....	36
<b>3 Taking Videos .....</b>	<b>37</b>
Taking a Video.....	37
Quickview—Reviewing the Video Just Taken.....	38
Using the Optical Zoom.....	39
Video Menus.....	39
Putting Yourself in the Video .....	40

---

4	Reviewing Pictures and Videos .....	41
	Picture and Video Icons .....	41
	Viewing Single Pictures and Videos .....	42
	Viewing Multiple Pictures and Videos .....	42
	Playing a Video .....	43
	Deleting Pictures and Videos .....	43
	Review Menus .....	44
	Magnifying Pictures .....	44
	Protecting Pictures and Videos From Deletion .....	45
	Running a Slide Show .....	46
	Copying Pictures and Videos .....	48
	Displaying Video Date .....	49
	Viewing Picture/Video Information .....	49
5	Tagging Pictures and Videos .....	51
	When Can I Tag My Pictures and Videos? .....	51
	Tagging Pictures for Printing .....	52
	Tagging Pictures and Videos for Emailing .....	53
	Tagging Pictures and Videos as Favorites .....	54
6	Customizing Your Camera Settings .....	55
	To Access Setup Mode/Menus .....	55
	Setup Menus .....	55
	Changing the Print Quantity Default .....	56
	Turning Off Quickview .....	56
	Turning On Liveview in Still Modes .....	57
	Turning Off the Shutter Sound .....	57

Turning Off the Low Light Auto Focus LED.....	58
Setting Video Out.....	58
Selecting a Language .....	59
Formatting Internal Memory or MMC/SD Card.....	60
Viewing Camera Information .....	61
Changing Advanced Digital Zoom.....	61
<b>7 Installing the Software .....</b>	<b>63</b>
WINDOWS System Requirements .....	63
MAC OS X System Requirements.....	64
MAC OS 8.6 and 9.x System Requirements .....	64
Install the Software.....	65
<b>8 Connecting to the Computer .....</b>	<b>67</b>
Using the EASYSHARE LS443 Camera Dock.....	67
Connecting With the USB Cable .....	72
Printing Pictures from Your Computer .....	73
<b>9 Troubleshooting .....</b>	<b>75</b>
Troubleshooting—Camera .....	75
Troubleshooting—Camera Dock.....	86
<b>10 Getting Help .....</b>	<b>89</b>
Helpful Web Links.....	89
Help in this Manual.....	89
Software Help .....	89
Telephone Customer Support.....	90

---

11	Appendix .....	93
	Camera Specifications.....	93
	Original Factory Settings—Camera .....	95
	Upgrading Your Software and Firmware .....	96
	Tips, Safety, Maintenance .....	96
	Storage Capacities.....	97
	Locating Pictures and Videos on a Card .....	98
	Card File Naming Conventions .....	98
	Using the Battery .....	100
	Power-Saving Features.....	101
	Regulatory Information.....	101





# 1 Getting Started

## Install Software First

Install the software from the KODAK EASYSHARE Software CD **before** connecting the camera (or camera dock) to the computer. Failure to do so may cause the software to load incorrectly.

See the Quick Start Guide or [WINDOWS System Requirements](#), page 63.

## Need This Guide in Larger Print?

For a large print version of this User's Guide:

- 1 Go to <http://www.kodak.com/go/ls443support>.
- 2 Under Explore EasyShare, click Service and Support.
- 3 Under Manuals/Guides, View PDF, click your language to open the User's Guide.
- 4 With the User's Guide open on a WINDOWS-based computer or MACINTOSH OS 8.6 or 9.x:
  - From the File menu, select Print.
  - In the Print window, select Fit to Page.
- 5 With the User's Guide open on MACINTOSH OS X:
  - From the File menu, select Page Setup.
  - Change Scale to 200%.
- 6 Print as usual.

## What Can I Do With My Camera?

**Capture Still Pictures**  —Enjoy point-and-shoot operation with flash, self timer, and zoom features. Use Auto, Sport, Night, Landscape, and Close-up modes to expand your capabilities.

**Capture Videos with Sound**  —Capture videos as QUICKTIME movies.

**Review**  —Display, protect, and delete pictures and videos. “Tag” pictures to print, email, and save as Favorites.

**Set Up**  —Customize your camera functions.

## What Can I Do With My Digital Pictures and Videos?

Install the software from the KODAK EASYSHARE Software CD, then:

**Transfer**—Transfer pictures and videos to your computer.

**Share**—Print pictures, order prints online, email pictures and videos.

**Print**—(see [page 73](#)) Print pictures directly to your home printer. Order prints online from Ofoto, a Kodak Company. Or purchase an optional KODAK Multimedia Card (MMC) or a Secure Digital (SD) card and:

- Automatically print to any printer with an MMC/SD slot
- Make prints at an MMC/SD-capable KODAK Picture Maker
- Take the card to your local photo retailer for professional printing

**Organize**—Use Favorites to organize, find, and retrieve your pictures on the computer.

**Edit**—Add special effects to your pictures, make a custom slide show, fix red-eye, crop, rotate, and much more.

Refer to the Quick Start Guide or KODAK EASYSHARE Software Help for details. Some MACINTOSH operating systems may support limited KODAK EASYSHARE Software features.

## Package Contents

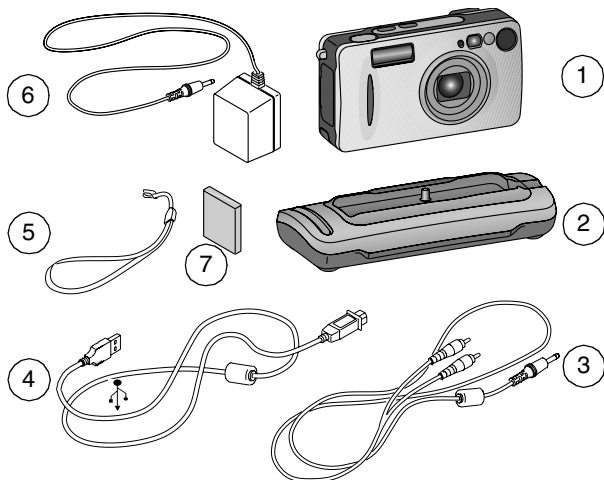

1 Camera

2 Camera Dock

3 Audio/Video cable

4 USB cable

5 Wrist strap

6 AC adapter

7 Battery

**Not shown:** User's Guide, Quick Start Guide, KODAK EASYSHARE Software CD.  
(In some countries, the User's Guide is provided on a CD instead of in printed form.)

## Attaching the Wrist Strap

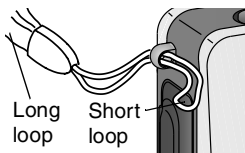

- 1 Thread the short loop of the wrist strap through the wrist strap post.
- 2 Thread the long loop through the short loop. Pull until secure.

## Loading the Battery



### CAUTION:

We recommend using only a **KODAK EASYSHARE Li-Ion Rechargeable Battery**. For important battery and warranty information, see [Using the Battery, page 100](#).

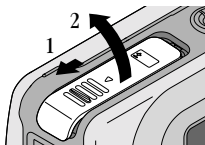

- 1 Turn off the camera.
- 2 Open the battery door.

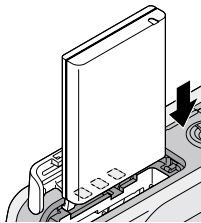

- 3 Orient the battery as shown.
- 4 Close the battery door.

NOTE: The battery may need charging the first time you use it. (See [page 71](#).)

## Using the AC Adapter

Use only the battery or supplied AC adapter to power the camera. The adapter will **not** charge the battery.

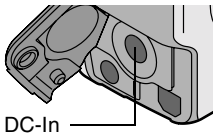

- 1 Connect the AC adapter to the DC-In port.
- 2 Connect the other end of the AC adapter to an electrical outlet.

Purchase batteries and AC adapters at <http://www.kodak.com/go/accessories>

## Mode Dial Settings

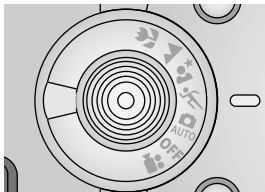

Icon	Mode	Purpose
	<b>Off</b>	Turns off the camera.
	<b>Auto</b>	For general picture-taking. Automatically sets exposure and focus. Flash fires if needed.
	<b>Sport</b>	For subjects that are in motion. Shutter speed is fast. Flash fires if needed.
	<b>Night</b>	For night scenes or low light conditions. Captures close and background subjects. Flash fires if needed. In dark scenes, the shutter speed is set between 1/1700 and 1/2 second. Place camera on a flat, steady surface or tripod to avoid camera shake.
	<b>Landscape</b>	For distant subjects. Flash does not fire unless you turn it on.*
	<b>Close-up</b>	For subjects 6 to 27.5 in. (13 to 70 cm) from the lens. Flash does not fire unless you turn it on.*
	<b>Video</b>	Captures video with sound. Flash does not fire.

To use individual modes, see [page 13](#).

\* To turn on the flash, see [page 22](#).

## Turning On the Camera

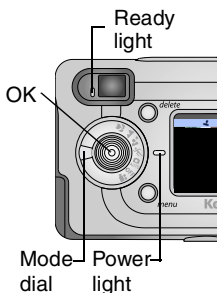

Turn the Mode dial from Off to any other position.

*The Power light glows green.*

*The ready light blinks while the camera performs a self-check, then glows green when the camera is ready to take pictures (or videos, if the mode dial is set to )*.

*In Still and Video modes, a status bar appears on the LCD.*

## Adjusting the Display

To	Do This
<b>Turn Liveview on</b> so that the LCD can be used as a viewfinder	Press the OK button. To turn it off, press the OK button again.
<b>Change the Liveview setting</b> so that it is on whenever the camera is on	See <a href="#">page 57</a> .
<b>Turn the status bar back on</b> after it times out	Move the joystick  .
<b>Turn off the camera</b>	Turn the Mode dial to Off. <i>The camera completes operations that are in process.</i>

## Setting the Date and Time

The Date & Time screen is displayed the first time you turn on the camera or if the battery is removed for more than 10 minutes. If this is the first time the camera has been turned on, go to Step 3.

To set the date and time after that:

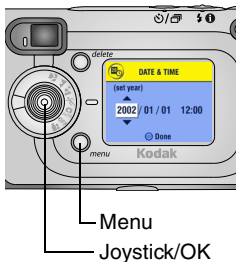

- 1 Turn on the camera, then press the Menu button.
- 2 Move the joystick ▲/▼ to highlight Setup, then press the OK button.
- 3 Move the joystick ▲/▼ to highlight Date & Time, then press the OK button.  
*The date format is YYYY/MM/DD. The time is displayed in a 24-hour format.*
- 4 Move the joystick ▲/▼ to adjust the date and time. Move the joystick ◀/▶ to advance to the next setting.
- 5 When finished, press the OK button.
- 6 Press the Menu button to exit the menu.

*The setting remains until you change it.*

**NOTE:** Depending on your computer operating system, KODAK EASYSHARE Software may allow your computer to automatically update the camera clock when you connect the camera. See the KODAK EASYSHARE Software Help for details.



## Checking Camera Status Bar



Status Bar

Screen Icon

To check the current camera settings, turn the Mode dial from the Off position.

For flash icons, see [page 22](#).

For Share icons, see [page 51](#).

### Status Bar Icons (Top of LCD)

Date stamp	Burst	Self Timer	Flash mode

	★★★ Best ★★ Better ★ Good	072	Internal memory Memory Card
Custom	Quality	Pictures remaining	Current Storage location

### Screen Icons (Bottom of LCD)

Auto	Sport	Night	Landscape	Close-up	Review	Video

Low battery	Exhausted battery (blinking)

## Inserting an MMC/SD Card

Optional MMC/SD cards provide removable, reusable storage for pictures and videos.



### CAUTION:

**The card can only be inserted one way; forcing it may damage the camera or card.**

**Do not insert or remove a card when the green ready light is blinking; doing so may damage your pictures, card, or camera.**

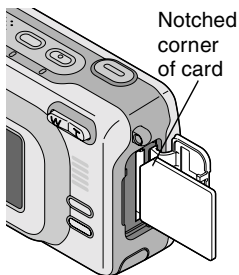

To insert an MMC/SD card:

- 1 Turn off the camera.
- 2 Open the card door.
- 3 Orient the card as shown on the card door.
- 4 Push the card into the slot to seat the connector. (To remove the card, turn off the camera. Push the card in, then release it. When the card is partially ejected, pull it out.)
- 5 Close the door.

See [page 97](#) for storage capacities. Purchase accessories at your KODAK retail dealer or <http://www.kodak.com/go/accessories>.

## Choosing Internal Memory or MMC/SD Card

The camera offers two options for storing pictures and videos:



**Internal Memory** —store pictures and videos in internal memory.

**MMC/SD Card** —store as many pictures and videos as you like, depending on the size of the card. Purchase accessories at your KODAK retail dealer or <http://www.kodak.com/go/accessories>. For storage capacities, see page 97.

### Managing Your Storage Location Setting

- 1 Turn on the camera.
- 2 Press the Menu button.
- 3 Move the joystick / to highlight Image Storage , then press the OK button.



- 4 Move the joystick / to highlight an option, then press the OK button:
 

**Auto (default)**—the camera uses the card if one is in the camera. If not, the camera uses internal memory.

**Internal Memory**—the camera always uses internal memory, even if a card is installed.



- 5 Highlight Continue, then press the OK button again.
- 6 The setting remains until you change it and applies to all camera functions.
- 7 Press the Menu button to exit the menu.

## Checking Your Storage Setting

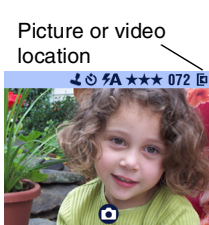
In **Still and Video modes**, the storage location icon that appears in the status bar indicates the camera's storage location. To check the location, either:



- Turn the Mode dial from the Off position, or
- In any capture mode, press ▼.



-  —Memory Card
-  —Internal Memory

## Checking a Picture or Video's Location

In **Review mode**, the storage location icon that appears with a picture indicates the location of the picture or video and the camera setting.



Press the Review button.

-  —Picture or video is stored on a card
-  —Picture or video is stored in internal memory

## Adding Optional Lenses

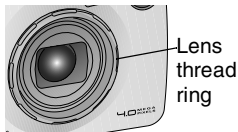

Purchase optional lenses at your Kodak retail dealer or on our Web site at <http://www.kodak.com/go/accessories>.

Turn the lens thread ring counterclockwise to remove it; then mount a lens.

## 2 Taking Pictures

The camera is ready to take pictures when you turn it on—even if you are in Review, Share, or Setup. (In Video mode, the camera captures video.) Before you take a picture, make sure your picture storage location is set the way you want it (see [page 11](#)).

### Taking Pictures in Auto Mode

Use Auto for general picture-taking. Exposure, focus, and flash are automatic.

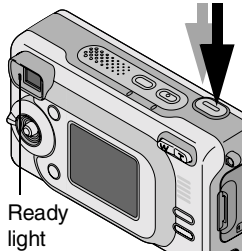

- 1 Turn the Mode dial to .  
*The LCD displays a mode description. To interrupt the description, press ▼.*
- 2 Use the viewfinder or LCD to frame your subject. (To turn the LCD Liveview on or off, press the OK button.)
- 3 Press the Shutter button *half-way* to set the exposure and focus. (Otherwise, picture could be too dark, too light, or blurry.)
- 4 When the ready light glows green, continue pressing the Shutter button *completely down* to take the picture.  
*When the ready light blinks green, the picture is being saved; you can still take pictures. If the ready light is red, wait until it turns green.*

<b>Default flash setting:</b>	Auto
<b>Available flash settings:</b>	Auto, Flash Off, Fill Flash, Red-eye
<b>Camera returns to default:</b>	When you change modes or turn off the camera.

## Using the Low Light Auto Focus LED

Low Light  
Auto Focus LED



When the Shutter button is pressed *half-way* down in low light, the Low Light Auto Focus LED may emit a brief beam of light. This light illuminates the subject so that:

- The camera can focus more effectively.
- You get better pictures.

To turn off the Low Light Auto Focus LED, see [page 58](#).

## Taking Pictures in Sport Mode

Use this mode when the subject is in motion.

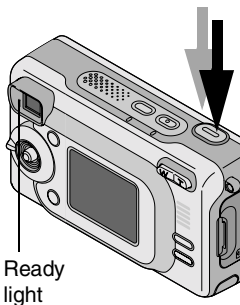

- 1 Turn the Mode dial to .

*The LCD displays a mode description. To interrupt the description, press ▼.*

- 2 Press the Shutter button *half-way* to set the exposure and focus.
- 3 When the ready light glows green, continue pressing the Shutter button **completely down** to take the picture.

*The ready light blinks green while the picture is saved.*

<b>Default flash setting:</b>	Auto
<b>Available flash settings:</b>	Auto, Flash Off, Fill Flash, Red-eye
<b>Camera returns to default:</b>	When you change modes or turn off the camera.

## Taking Pictures in Night Mode

Use this mode for night scenes or low light conditions. The flash illuminates close subjects. A longer exposure captures more detail of background subjects. The Low Light Auto Focus LED (see [page 14](#)) turns on as needed to assist with focus and capture in low light.

**NOTE:** To avoid blurry pictures caused by slow shutter speed, place the camera on a flat, steady surface or use a tripod.

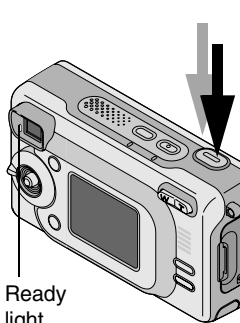

Ready light

- 1 Turn the Mode dial to .

*The LCD displays a mode description. To interrupt the description, press ▼.*

- 2 Press the Shutter button **half-way** to set the exposure and focus.

- 3 When the ready light glows green, continue pressing the Shutter button **completely down** to take the picture.



*The ready light blinks green while the picture is saved.*

<b>Default flash setting:</b>	Auto
<b>Available flash settings:</b>	Auto, Flash Off, Fill Flash, Red-eye
<b>Camera returns to default:</b>	When you change modes or turn off the camera.

## Taking Pictures in Landscape Mode

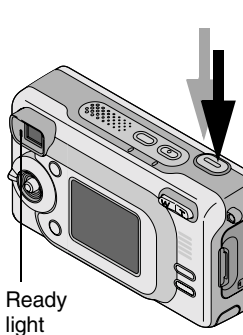
Use this mode to capture distant subjects, such as landscape scenes.



- 1 Turn the Mode dial to .  
*The LCD displays a mode description. To interrupt the description, press .*
- 2 Press the Shutter button **half-way** to set the exposure.
- 3 When the ready light glows green, continue pressing the Shutter button **completely down** to take the picture.  
*The ready light blinks green while the picture is saved.*

<b>Default flash setting:</b>	Off
<b>Available flash settings:</b>	Auto, Flash Off, Fill Flash, Red-eye
<b>Camera returns to default:</b>	When you change modes or turn off the camera.



## Taking Pictures in Close-up Mode

Use this mode to capture subjects 6 to 27.5 in. (13 to 70 cm) from the lens.

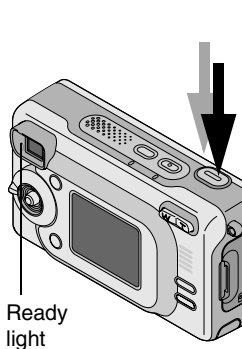

- 1 Turn the Mode dial to .
 

*The LCD displays a mode description. To interrupt the description, press ▼.*
- 2 Press the Shutter button **half-way** to set the exposure and focus.
- 3 When the ready light glows green, continue pressing the Shutter button **completely down** to take the picture.
 

*The ready light blinks green while the picture is saved.*

<b>Default flash setting:</b>	Off
<b>Available flash settings:</b>	Auto, Flash Off, Fill Flash, Red-eye
<b>Camera returns to default:</b>	When you change modes or turn off the camera.

## Liveview—Using the LCD to Frame Your Subject

When you turn on Liveview, the LCD displays a live image of what the lens sees. Use the LCD to frame your subject.



- 1 Turn the Mode dial to any Still position.
- 2 Press the OK button to turn on Liveview.
- 3 Frame your subject in the LCD.
- 4 Press the Shutter button *half-way* to set the exposure and focus, then continue pressing *completely down* to take the picture.
- 5 To turn off Liveview, press the OK button.

NOTE: Liveview quickly depletes battery power. To conserve battery power, turn off Liveview and use the Viewfinder to frame your subject.

To use the Auto Focus Framing Marks, see [page 20](#).

To change the Liveview setting so that it is on whenever the camera is on, see [page 57](#).

## Quickview—Reviewing the Picture Just Taken

After you take a picture, the LCD displays a Quickview of that picture for approximately 5 seconds. While the picture is displayed, you can:

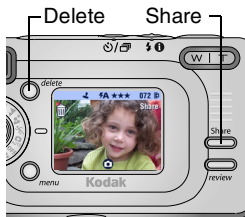

- **Review it:** If you take no action, the picture is saved.
- **Share it:** Press the Share button to tag the picture for print, email, or as a Favorite. (See [Tagging Pictures and Videos](#), page 51.)
- **Delete it:** Press the Delete button while the picture and  are displayed. Follow the prompts to delete the picture.

**NOTE:** Only the final of a burst series of pictures (see [page 25](#)) is displayed during Quickview. If Delete is selected, all pictures in the burst series are deleted. To delete selectively, do so in Review (see [page 43](#)).

To save battery power, you can turn off the Quickview feature. (See [page 56](#).)

## Using the Auto Focus Framing Marks

For the best possible pictures, the camera attempts to focus on foreground subjects (even if the subjects are not centered in the scene).





NOTE: Auto Focus framing marks appear only when the LCD is turned on.

Framing marks do not appear in Landscape mode. When the focus is set to Center Zone, focus is fixed at Center wide (see [page 32](#)).

- 1 In any Still mode (except Landscape), press the OK button.

*The LCD turns on.*

- 2 Press the Shutter button *half-way* to set the exposure and focus.
- 3 The Auto Focus framing marks depict the main focus area or areas. If the camera is not focusing on the desired subject (or if the framing marks disappear), release your finger, recompose the scene, and repeat Step 2. When the framing marks turn red, focus is accomplished.

While Shutter Button is Pressed Half-way	
	Center focus
	Center wide focus
	Side focus
	Center and side focus
	Left and right focus

- 4 Continue pressing the Shutter button *completely down* to take the picture.

## Using the Optical Zoom

Use Optical Zoom to get up to 3X closer to your subject. When you turn on the camera, the lens extends to the Wide Angle position.

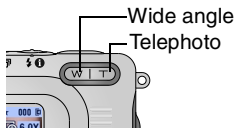

- 1 Use the viewfinder or LCD to frame your subject.
- 2 Press the Telephoto (T) button to zoom in. Press Wide Angle (W) button to zoom out.

*The lens extends or retracts. The viewfinder or LCD displays the zoomed image.*

- 3 Press the Shutter button **half-way** to set the exposure and focus, then continue pressing **completely down** to take the picture.

NOTE: The lens retracts when the camera is turned off.

## Using the Advanced Digital Zoom

Use Advanced Digital Zoom to get an additional 3.3X magnification beyond Optical Zoom.

**IMPORTANT:** *Even with the camera's Advanced Digital Zoom, you may notice a decrease in printed image quality when using Digital Zoom.*

- 1 Press the OK button to turn on Liveview.
- 2 Press the Telephoto (T) button to the Optical Zoom limit. Release the button, then press it again.

*The LCD displays the zoomed image and the magnification  6.0X.*

NOTE: You can change the way the digital zoom is turned on. See [page 61](#).

- 3 Press the Shutter button **half-way** to set the exposure and focus, then **completely down** to take the picture.

## Using the Flash

Use the flash when you take pictures at night, indoors, or outdoors in heavy shadows. The flash setting can be changed in any Still mode; the default flash setting is restored when you exit the mode or turn off the camera.

### Flash Range

- Wide angle: 1.5 to 10.8 ft (0.5 to 3.3 m)
- Telephoto: 1.5 to 6.2 ft (0.5 to 1.9 m)

### Turning On The Flash



Press the  button repeatedly to scroll through the flash options.

*The flash icon that is displayed on the LCD status bar (page 9) is the active option.*



**Auto Flash**—flash fires when the lighting conditions require it.



**Off**—flash never fires.









**Fill**—flash fires every time you take a picture, regardless of the lighting conditions.



**Red-eye**—flash fires once so the subject's eyes become accustomed to the flash, then fires again when the picture is taken.

## Flash Settings In Each Mode

Icon	Mode	Default Flash Setting	Available Flash Settings	Camera Returns to the Default Flash Setting
	<b>Auto</b>	Auto or Red-eye	Auto, Flash Off, Fill Flash, Red-eye	When you exit the mode or turn off the camera
	<b>Sport</b>	Auto		
	<b>Night</b>	Auto		
	<b>Landscape</b>	Off		
	<b>Close-up</b>	Off		
	<b>Video</b>	Off	None	Flash cannot be turned on

## Other Flash Screen Information

Custom icon



Current features



When the Custom **i** icon appears in the status bar, press the Flash button.

*The LCD displays the features that are currently set.*

## Putting Yourself in the Picture

The Self Timer creates a 10-second delay between the time you press the Shutter button and the time the picture is taken.



- 1 Place the camera on a flat surface or use a tripod.
- 2 In any Still mode, press the Self Timer button.

*The Self Timer icon  appears on the status bar.*

- 3 Compose the scene. Then press the Shutter button **half-way** to set the exposure and focus, then continue pressing **completely down**. Move into the scene.

*The white Self Timer light blinks slowly for 8 seconds (then quickly for 2 seconds) before the picture is taken.*

*The Self Timer turns off after you take the picture or if you change modes.*

*To cancel the Self Timer before the picture is taken, press the Self Timer button. (The Self Timer setting remains active.)*



## Taking a Burst Series of Pictures

Burst lets you to take up to 3 pictures in quick succession. Burst is ideal for taking pictures of sporting events or moving objects. When you use the Burst feature, the Flash and the Self Timer are disabled.

### Turn On Burst

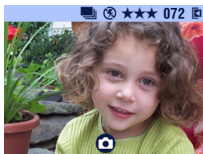

In any Still mode, press the Self Timer button **twice**.

*The Burst icon  appears on the status bar.*

NOTE: The setting remains until you change it or turn off the camera.









### Take the Pictures

- 1 Press the Shutter button **half-way** to set the auto-focus and exposure for all the pictures in the sequence.
- 2 Continue pressing and holding the Shutter button **completely down** to take the pictures.

*The camera takes up to 3 pictures in quick succession. It stops taking pictures when the Shutter button is released, when 3 pictures are taken, or when there is no more storage space.*

*Exposure, focus, white balance, and orientation that are set for the first picture are applied to all 3 pictures.*

## Still Menus

	Image Storage (page 11)	[ ]	Focus Zone (page 32)
	Exposure Compensation (page 27)	<b>ISO</b>	ISO Speed (page 33)
	White Balance (page 28)	<b>LT</b>	Long Time Exposure (page 34)
	Picture Quality (page 29)		Date Stamp (page 35)
	Color Mode (page 30)		Orientation Sensor (page 36)
	Exposure Metering (page 31)		Setup Menu (page 55)

## Setting Exposure Compensation

Use Exposure Compensation to control how much light enters the camera. This setting is useful for taking pictures in very large rooms, under low light, without a flash.

Adjust the exposure by plus or minus 2 steps in 1/2-step increments.

NOTE: Exposure Compensation cannot be used with Long Time Exposure.

- 1 In any Still mode, press the Menu button.
- 2 Move the joystick ▲/▼ to highlight Exposure Compensation , then press the OK button.

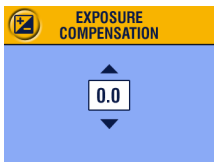

- 3 Move the joystick ▲/▼ to select the Exposure Compensation setting.
  - If pictures are too light, decrease the value.
  - If pictures are too dark, increase the value.
- 4 Press the OK button to accept the change.
- 5 Press the Menu button to exit the menu.
- 6 Use the LCD to frame your subject. Press the Shutter button *half-way* to set the focus, then continue pressing *completely down* to take the picture.

*This setting remains until you move the Mode dial or turn off the camera.*

## Setting White Balance

Whites can look white in daylight, but different under other lighting conditions. Use White Balance to correct the color shifts that result from shooting pictures under different light sources.

- 1 In any Still mode, press the Menu button.
- 2 Move the joystick ▲/▼ to highlight White Balance , then press the OK button.

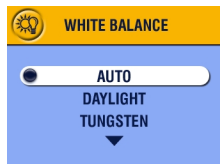

- 3 Move the joystick ▲/▼ to highlight an option, then press the OK button.

**Auto (default)**— automatically corrects white balance. Ideal for general picture taking.

**Daylight**—for pictures in natural lighting.

**Tungsten**—corrects the orange cast of household light bulbs. Ideal for indoor pictures under tungsten or halogen lighting without flash.

**Fluorescent**—corrects the green cast of fluorescent lighting. Ideal for indoor pictures under fluorescent lighting without flash.

- 4 Press the Menu button to exit the menu.

*This setting remains until you change it or turn off the camera.*

## Setting Picture Quality

Use the Quality setting to select a picture resolution.

- 1 In any Still mode, press the Menu button.



- 2 Move the joystick  $\blacktriangle/\blacktriangledown$  to highlight Quality  $\star$ , then press the OK button.

- 3 Highlight an option:

**Best  $\star\star\star$  (4.0 MP)**—for printing up to 20 x 30 in. (50 x 75 cm); pictures are highest resolution and largest file size.

$\star\star\star$  *appears on the status bar.*

**Better  $\star\star$  (2.2 MP)**—for printing up to 8 x 10 in. (20 x 25 cm); pictures are medium resolution with smaller file size.

$\star\star$  *appears on the status bar.*

**Good  $\star$  (1.0 MP)**—for emailing, Internet, or screen display; pictures are lowest resolution and smallest file size.

$\star$  *appears on the status bar.*

- 4 Press the OK button.
- 5 Press the Menu button to exit the menu.
- 6 This setting remains until you change it.

## Setting Color Mode

Use Color Mode to control color tones and moods.

- 1 In any Still mode, press the Menu button.
- 2 Move the joystick ▲/▼ to highlight Color Mode , then press the OK button.



- 3 Move the joystick ▲/▼ to highlight an option, then press the OK button.

**Color (default)**—for color pictures

**Black & White**—for black-and-white pictures

**Sepia**—for pictures with a reddish-brown, antique look

- 4 Press the Menu button to exit the menu.

*This setting remains until you change it or turn off the camera.*

## Setting Exposure Metering

Use Exposure Metering to ensure that the proper amount of light enters the camera lens.

- 1 In any Still mode, press the Menu button.
- 2 Move the joystick ▲/▼ to highlight Exposure Metering , then press the OK button.

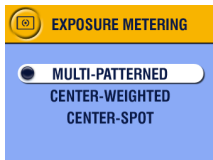

- 3 Move the joystick ▲/▼ to highlight an option, then press the OK button.

**Multi-patterned**—evaluates lighting conditions throughout the image to give an optimum picture exposure. Ideal for general picture taking.

**Center-weighted**—evaluates the lighting conditions of the subject centered in the viewfinder. Ideal for backlit subjects.

**Center-spot**—similar to Center-weighted, except the metering is concentrated on a smaller area of the subject centered in the viewfinder. Ideal when an exact exposure of a specific area in the picture is needed.

- 4 Press the Menu button to exit the menu.

*This setting remains until you change it.*

## Setting Focus Zone

Use the Focus Zone to select a large or a concentrated area of focus.

- 1 In any Still mode, press the Menu button.
- 2 Move the joystick ▲/▼ to highlight Focus Zone [ ], then press the OK button.

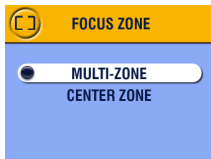

- 3 Move the joystick ▲/▼ to highlight an option, then press the OK button.

**Multi-zone (default)**—evaluates 3 zones to give an even picture focus. Ideal for general picture taking.

See [Using the Auto Focus Framing Marks, page 20](#).

**Center zone**—evaluates the small area centered in the viewfinder. Ideal when precise focus of a specific area in the picture is needed.

- 4 Press the Menu button to exit the menu.

*This setting remains until you change it.*



## Setting ISO Speed

The ISO setting controls the camera's sensitivity to light. Use a lower ISO setting in brightly lit scenes; use a higher ISO setting for low-light scenes.

**NOTE:** Higher ISO speeds may create a picture that is “noisier” than a picture taken at lower ISO speeds. These settings are available only in Auto, Landscape, and Close-up modes.

- 1 Press the Menu button.
- 2 Move the joystick ▲/▼ to highlight ISO Speed **ISO**, then press the OK button.

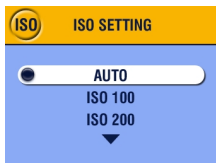

- 3 Move the joystick ▲/▼ to highlight an option, then press the OK button.

**AUTO (default)**—sets an ISO speed based on scene brightness. Ideal for general picture taking.

**ISO 100**—for daylight pictures in bright sun, when fine detail is needed. Ideal for portraits or nature scenes.

**ISO 200**—for cloudy, overcast days. Ideal when you need extra speed without sacrificing image quality.

**ISO 400**—for dusk or night pictures when flash is prohibited. Ideal for sporting events and excellent for indoor shots with or without flash.

- 4 Press the Menu button to exit the menu.

*This setting remains until you change it or turn off the camera.*

## Setting Long Time Exposure

Use Long Time Exposure to control how long the shutter stays open. Settings are: Off, 0.7, 1, 1.5, 2, 3, and 4 seconds.

NOTE: Long Time Exposure cannot be used with Exposure Compensation. If ISO speed has been changed, it is reset to Auto.

### Set Long Time Exposure

- 1 In any Still mode, press the Menu button.
- 2 Move the joystick ▲/▼ to highlight Long Time Exposure **LT** , then press the OK button.
- 3 Move the joystick ▲/▼ to select an option, then press the OK button.
- 4 Press the Menu button to exit the menu.

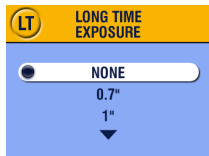

### Take the Picture

- 1 Place the camera on a flat surface or use a tripod.
- 2 Use the LCD to frame your subject. Press the Shutter button **half-way** to set the focus, then continue pressing **completely down** to take the picture.

*This setting remains until you move the Mode dial or turn off the camera.*

<b>Default flash setting:</b>	Off
<b>Available flash settings:</b>	Auto, Flash Off, Fill Flash, Red-eye
<b>Camera returns to default:</b>	When you change modes or turn off the camera.

## Placing the Date on Pictures

Use the Date Stamp setting to imprint the date on your pictures.

- 1 Make sure the camera clock is set to the correct date ([page 8](#)).
- 2 In any Still mode, press the Menu button.
- 3 Move the joystick ▲/▼ to highlight Date Stamp , then press the OK button.

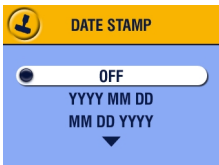

- 4 Move the joystick ▲/▼ to highlight an option, then press the OK button.
- 5 Press the Menu button to exit the menu.

*The current date is printed in the bottom right corner of new pictures. This setting remains until you change it.*

## Setting the Orientation Sensor

If you rotate the camera to take a picture (for example, a portrait shot), the Orientation Sensor reorients the picture so that it is displayed correct side up. The Orientation Sensor is turned on as the default. You can turn it off so that pictures are displayed in their original orientation.

**NOTE:** When your subject is above or below you (such as pictures of an object in the sky, on the ground, or when pointing down at small objects on a table), **turn off the Orientation Sensor** so that pictures are not rotated unnecessarily.

- 1 In any Still mode, press the Menu button.
- 2 Move the joystick  $\blacktriangle/\blacktriangledown$  to highlight Orientation Sensor , then press the OK button.

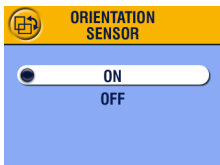

- 3 Move the joystick  $\blacktriangle/\blacktriangledown$  to highlight On or Off, then press the OK button.
- 4 Press the Menu button to exit the menu.

*This setting remains until you change it.*

## Other Features

- [Choosing Internal Memory or MMC/SD Card, page 11](#)
- [Taking Videos, page 37](#)
- [Tagging Pictures and Videos, page 51](#)

## 3 Taking Videos

Use the Video setting  to take videos or to customize video-taking settings. Before you take a video, make sure your picture storage location is set the way you want it (see [page 11](#)).

NOTE: Flash is not available in Video mode. You can change Optical Zoom before (but not during) video recording.

### Taking a Video

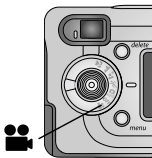

- 1 Turn the Mode dial to Video .

*A live image, the status bar, and the recording time available appear on the LCD.*

- 2 Use the viewfinder or LCD to frame your subject.

NOTE: To conserve battery power, press the OK button to turn off the LCD.

- 3 Press the Shutter button completely down and release within 2 seconds.  
*The ready light blinks green while the camera is recording. Recording stops when you press the Shutter button again or when the current storage location is full.*

NOTE: If you prefer, you can press and hold the Shutter button completely down for more than 2 seconds to record. Release the Shutter button to stop recording.

See [page 97](#) for video storage capacities.

## Quickview—Reviewing the Video Just Taken

After you take a video, the LCD displays the first frame of the video for approximately 5 seconds. While the frame is displayed, you can:

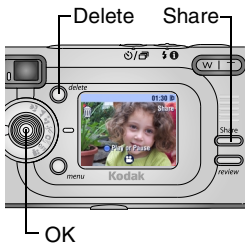

- **Review it:** If you take no action, the video is saved.
- **Play it:** Press the OK button. Press ▲/▼ to adjust the volume. Press OK again to pause the video.
- **Share it:** Press the Share button to tag the video for email or as a Favorite (see [page 51](#)).
- **Delete it:** Press the Delete button while the video and  are displayed.

To save battery power, you can turn off the Quickview feature. (See [page 56](#).) When Quickview is turned off, the video is not displayed on the LCD after you take it.

## Using the Optical Zoom

Use Optical Zoom to get up to 3X closer to your subject. When you turn on the camera, the lens is set to the Wide Angle position.

NOTE: You can change Optical Zoom before (but not during) video recording.

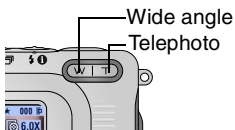



- 1 Use the viewfinder or LCD to frame your subject.
- 2 Press the Telephoto (T) button to zoom in. Press Wide Angle (W) button to zoom out.

*The lens extends or retracts. The viewfinder or LCD displays the zoomed image.*

- 3 Press the Shutter button to take the video.

## Video Menus

	Image Storage ( <a href="#">page 11</a> )
	Setup Menu ( <a href="#">page 55</a> )

## Putting Yourself in the Video

The Self Timer creates a 10-second delay between the time you press the Shutter button and the time video recording begins.

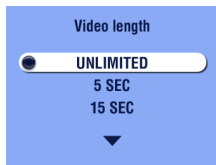
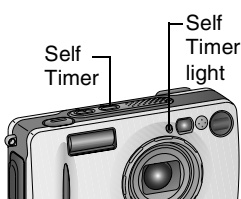

- 1 Place the camera on a flat surface or use a tripod.
- 2 Turn the Mode dial to Video , then press the Self Timer button.

- 3 Move the joystick  to highlight a Video Length option, then press the OK button:

**Unlimited**—records until you stop recording or until storage is full.

**Seconds**—records for the specified time or until storage is full.

- 4 Compose the scene, then press the Shutter button completely down. Move into the scene.

*The white Self Timer light blinks slowly for 8 seconds, quickly for 2 seconds. The Self Timer turns off after you take the video.*

**NOTE:** To stop recording before the specified time, press the Shutter button. (The Self Timer setting remains active.) If the current storage location does not have adequate space, some video length options are not displayed. See [page 97](#) for video storage capacities.



## 4 Reviewing Pictures and Videos

Press the Review button to view and work with your pictures and videos.

**Remember, press the Shutter button to take a picture anytime, even in Review.**



- 1 Press the Review button.

*The LCD displays the last picture or video taken.*

- 2 Press the Review button to exit Review.

### Picture and Video Icons

	Email
	Favorite
	Print # of copies
	Protect
	<b>072</b> Picture/video number
	Internal Picture Location
	Card
	Low battery
	Exhausted battery

## Viewing Single Pictures and Videos

- 1 Press the Review button.
- 2 Move the joystick  $\blacktriangleleft/\blacktriangleright$  to scroll backward or forward through pictures and videos. For fast scrolling, press and hold a  $\blacktriangleleft/\blacktriangleright$  button.

## Viewing Multiple Pictures and Videos



- 1 Press the Review button.
- 2 Either move the joystick  $\blacktriangledown$ , or
  - Press the Menu button.
  - Move the joystick  $\blacktriangleup/\blacktriangledown$  to highlight Multi-up .
  - Press the OK button.



*Thumbnails of nine pictures and videos are displayed at once.*

- 3 Move the joystick  $\blacktriangleup/\blacktriangledown$  to display the previous or next row of thumbnails.
- 4 Move the joystick  $\blacktriangleleft/\blacktriangleright$  to scroll through the thumbnails one at a time.

*The selected picture is highlighted in yellow.*

- 5 Press the OK button to display a single view of the selected picture.

## Playing a Video

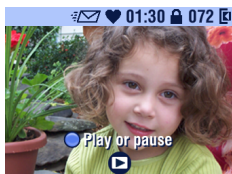

- To play a video, press the OK button. To pause, press the OK button during playback.
- To adjust the volume, move the joystick ▲/▼ during playback.
- To rewind a video, move the joystick ◀ during playback. To play the video, press the OK button.
- To go to the previous or next picture or video, move the joystick ◀/▶ while no video is playing.

## Deleting Pictures and Videos

- 1 Press the Review button.
- 2 Move the joystick ◀/▶ to locate a picture or video (or highlight one in multiple view), then press the Delete button.

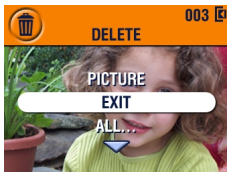

- 3 Move the joystick ▲/▼ to highlight an option, then press the OK button:

**PICTURE or VIDEO**—deletes the displayed picture or video.









**EXIT**—exits the Delete screen.

**ALL**—deletes all pictures and videos from your current storage location.

**NOTE:** Protected pictures and videos cannot be deleted in this manner. Remove protection before deleting ([page 45](#)).

- 4 After deleting, move the joystick ◀/▶ to stay in delete mode and scroll to different pictures and videos. To exit Delete, press the Delete button.

## Review Menus

	Magnify (page 44)		Video Date Display (page 49)
	Protect (page 45)		Multi-up (page 42)
	Image Storage (page 11)		Picture Info (page 49)
	Slide Show (page 46)		Setup Menu (page 55)
	Copy (page 48)		

## Magnifying Pictures





Use the Magnify feature to zoom in to different areas of a picture.

1 Press the Review button, then locate a picture.





2 To magnify at 2X, press the OK button. To magnify at 4X, press the OK button again.

*The picture is magnified. The Magnify icon  and the magnification value are displayed.*

3 Move the joystick  /   /  to navigate to different parts of the picture.

4 Press the OK button to redisplay the picture at the 1X (original) size.

5 Move the joystick  /  to locate a different picture, or press the Review button to exit Review mode.

## Protecting Pictures and Videos From Deletion

- 1 Press the Review button, then locate the picture or video to protect.
- 2 Press the Menu button.

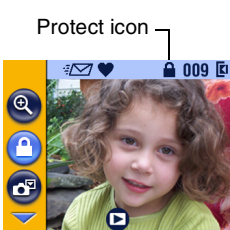

- 3 Move the joystick ▲/▼ to highlight Protect , then press the OK button.

*The picture or video is protected and cannot be deleted. The Protect icon  appears with the protected picture or video.*



### CAUTION:

**Formatting internal memory or MMC/SD card deletes all (including protected) pictures, videos, and email addresses.**

- 4 To remove protection, press the OK button again.
- 5 Press the Menu button to exit the menu.

## Running a Slide Show

Use the Slide Show to display your pictures and videos on the LCD. To run a slide show on a television or on any external device, see [page 47](#).

### Starting the Slide Show

- 1 Press the Review button, then press the Menu button.
- 2 Move the joystick  $\blacktriangle/\blacktriangledown$  to highlight Slide Show , then press the OK button.



- 3 Move the joystick  $\blacktriangle/\blacktriangledown$  to highlight Begin Show, then press the OK button.

*Each picture and video is displayed once, in the order in which you took them. Then the camera returns to the Menu screen.*

- 4 To cancel the Slide Show, press the OK button.

### Changing the Slide Show Display Interval

The default interval setting displays each picture for 5 seconds. You can increase the display interval to up to 60 seconds.

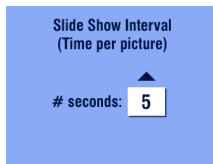

- 1 On the Slide Show menu, move the joystick  $\blacktriangle/\blacktriangledown$  to highlight Interval, then press the OK button.
- 2 Select a display interval.  
To scroll through the seconds quickly, press and hold  $\blacktriangle/\blacktriangledown$ .
- 3 Press the OK button.

*The interval setting remains until you change it.*

## Turning On Slide Show Loop

When you turn on Loop, the slide show is continuously repeated.

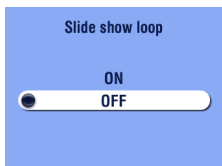

- 1 On the Slide Show menu, move the joystick  $\blacktriangle/\blacktriangledown$  to highlight Loop, then press the OK button.
- 2 Move the joystick  $\blacktriangle/\blacktriangledown$  to highlight On, then press the OK button.

*When you start a slide show, it repeats until you cancel it by pressing the OK button or until battery power is exhausted. The Loop setting remains until you change it.*

## Displaying Pictures and Videos on a Television

You can display pictures and videos on a television, computer monitor, or any device equipped with a video input. (Images may not look as good on a television as on a computer monitor or when printed.)

NOTE: Ensure that the Video Out setting is correctly set to NTSC or PAL (page 58).

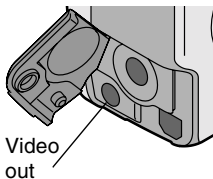

- 1 Connect the audio/video cable from the camera video-out port to the television video-in port. (Refer to your television User's Guide for details.)  
*The camera LCD turns off; the television screen acts as the camera display.*
- 2 Review pictures and videos on the television screen.

NOTE: If you connect or disconnect the audio/video cable while a slide show is running, the slide show stops.

## Copying Pictures and Videos

You can copy pictures and videos from a card to internal memory or from internal memory to a card.

### Before you copy, make sure that:

- A card is inserted in the camera.
- The camera's picture storage location is set to the location **from** which you are copying. See [Choosing Internal Memory or MMC/SD Card](#), page 11.

### Copy pictures or videos:

- 1 Press the Review button, then press the Menu button.
- 2 Move the joystick  $\blacktriangle/\blacktriangledown$  to highlight Copy  $\blacktriangleright\blacktriangleright$ , then press the OK button.

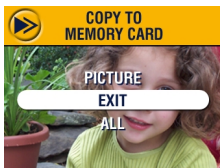

- 3 Move the joystick  $\blacktriangle/\blacktriangledown$  to highlight an option:

**PICTURE or VIDEO**—copies the current picture.

**EXIT**—returns to the Copy screen.

**ALL**—copies all pictures and videos from your selected storage location to the other location.

- 4 Press the OK button.
- 5 A progress bar monitors the copy process until complete. (For information on picture numbering, see [page 98](#).)

### NOTE:

- Pictures and videos are copied, not moved. To remove pictures and videos from the original location after they are copied, delete them (see [page 43](#)).
- Tags that you applied for print, email, and favorites are not copied. Protection settings are not copied. To apply protection to a picture or video, see [page 45](#).



## Displaying Video Date

To display the capture date and time (only during video playback on the camera):

- 1 Press the Review button, then press the Menu button.
- 2 Move the joystick  $\blacktriangle/\blacktriangledown$  to highlight Video Date Display, then press the OK button.



- 3 Move the joystick  $\blacktriangle/\blacktriangledown$  to highlight an option, then press the OK button.
- 4 Press the Menu button to exit the menu.

*The capture date and time appear during video playback on the camera. This setting remains until you change it.*

## Viewing Picture/Video Information

- 1 Press the Review button, then press the Menu button.

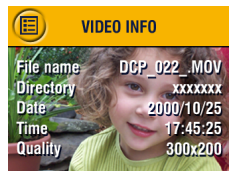

- 2 Move the joystick  $\blacktriangle/\blacktriangledown$  to highlight About, then press the OK button.

*Information about the picture or video is displayed.*

- 3 To view information on the next or previous picture or video, move the joystick  $\blacktriangle/\blacktriangleright$ . Press the Menu button to exit the menu.



# 5 Tagging Pictures and Videos





The Share button lets you “tag” your pictures and videos. When they are transferred to your computer, you can share:

## Tagged Pictures

- By print
- By email
- As Favorites, for easy organization on your computer

## Tagged Videos

- By email
- As Favorites

	 Print ( <a href="#">page 52</a> )
	 Email ( <a href="#">page 53</a> )
	 Favorite ( <a href="#">page 54</a> )

## When Can I Tag My Pictures and Videos?

Tag pictures and videos whenever they appear on the LCD:

- Just after you take them, during Quickview (see [page 19](#) and [page 38](#))
- After pressing the Review button (see [page 41](#))

NOTE: Tags remain until removed. If a tagged picture or video is copied, the tag is **not** copied. In a burst series, only the last picture is tagged during Quickview. For details on organizing, printing, or emailing, see the Quick Start Guide or KODAK EASYSHARE Software Help.

## Tagging Pictures for Printing



- 1 Press the Review button, then locate a picture.
- 2 Press the Share button. Highlight Print , then press the OK button.\*
- 3 Press  $\blacktriangle/\blacktriangledown$  to select the number of copies (0-99). Zero removes the tag for that picture.
- 4 Press the OK button. Press the Share button to exit the Share menu.

*The Print icon  appears on the status bar. The default quantity is one. (To change the default, see [page 56](#).)*

\* To tag all pictures in the storage location, highlight Print All , press the OK button, then indicate the number of copies as described above. Print All is not available in Quickview.

To remove the print tagging for all pictures in the storage location, highlight Cancel Prints, then press the OK button. Cancel Prints is not available in Quickview.



## Printing Tagged Pictures

To print pictures, see [page 73](#).

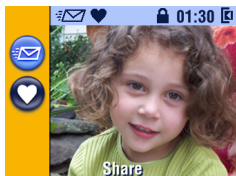

## Tagging Pictures and Videos for Emailing

First, use KODAK EASYSHARE Software to create an email address book on your computer. Then, copy up to 32 email addresses to the camera's internal memory. See the Quick Start Guide or KODAK EASYSHARE Software Help for details.



- 1 Press the Review button, then locate a picture or video.
- 2 Press the Share button. Highlight Email , then press the OK button.
- 3 Move the joystick / to highlight an email address, then press the OK button. To send the picture to more than one person, repeat step 3 for each address.

*Selected addresses are noted with a check mark; the email icon  appears on the status bar.*

- 4 To remove a selection, highlight a checked address and press the OK button. To remove all email selections, highlight Clear All.
- 5 Move the joystick / to highlight Exit, then press the OK button.  
*Your selections are saved.*
- 6 Press the Share button to exit the Share menu.

### Emailing Tagged Pictures and Videos

When you transfer the tagged pictures and videos to your computer, the KODAK EASYSHARE Software email screen opens and lets you immediately send the pictures and videos to the addresses you specified.

See the Quick Start Guide or KODAK EASYSHARE Software Help for details on address books and emailing.

## Tagging Pictures and Videos as Favorites

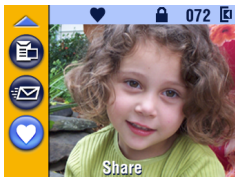

- 1 Press the Review button, then locate a picture or video.
- 2 Press the Share button.
- 3 Move the joystick  $\blacktriangle/\blacktriangledown$  to highlight Favorite  $\heartsuit$ , then press the OK button.  
*The Favorite icon  $\heartsuit$  appears on the status bar.*
- 4 To remove the tag, press the OK button again.
- 5 Press the Share button to exit the Share menu.

### Using Favorites On Your Computer

When you transfer tagged pictures and videos to your computer, you can retrieve, organize, and label them by subject, date, event, or any category you choose.

See the Quick Start Guide or KODAK EASYSHARE Software Help for details.













# 6 Customizing Your Camera Settings

Use Setup to customize camera settings according to your preferences.

## To Access Setup Mode/Menus

- 1 In any mode, press the Menu button.
- 2 Move the joystick ▲/▼ to highlight Setup , then press the OK button.

## Setup Menus

	Return to previous menu		Date & Time Set (page 8)
	Default Print Quantity (page 56)		Video Out (page 58)
	Quickview (page 56)		Language (page 59)
	Liveview (page 57)		Format (page 60)
	Shutter Sound (page 57)		About (page 61)
	Low Light Auto Focus LED (page 58)		Advanced Digital Zoom (page 61)

## Changing the Print Quantity Default

The Default Print Quantity setting determines the value that is displayed on the Share Print screen (page 52). The default value is 1.

- 1 Press the Menu button.
- 2 Move the joystick ▲/▼ to highlight Setup ☰, then press the OK button.
- 3 Move the joystick ▲/▼ to highlight Default Print Quantity 📄, then press the OK button.



- 4 Move the joystick ▲/▼ to select the new default quantity, then press the OK button.
- 5 Press the Menu button to exit the menu.

*This setting remains until you change it.*

## Turning Off Quickview

After you take a picture or video, Quickview displays it on the LCD for approximately 5 seconds (see page 19 and page 38). To save battery power, turn off Quickview.

- 1 Press the Menu button.
- 2 Move the joystick ▲/▼ to highlight Setup ☰, then press the OK button.
- 3 Move the joystick to highlight Quickview 👁, then press the OK button.

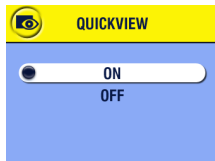

- 4 Move the joystick to highlight Off, then press the OK button.
- 5 Press the Menu button to exit the menu.

*The picture is not displayed on the LCD after you take it. To see the picture or video, press the Review button. This setting remains until you change it.*



## Turning On Liveview in Still Modes

The Liveview feature lets you use the LCD as a viewfinder (see [page 18](#)). The default setting is Off; press the OK button to turn the LCD on when you need it.

**NOTE:** Liveview quickly depletes battery power; use it sparingly. The Liveview default setting is On in Video and Close-up modes.

- 1 Press the Menu button.
- 2 Move the joystick ▲/▼ to highlight Setup , then press the OK button.
- 3 Move the joystick to highlight Liveview , then press the OK button.



- 4 Highlight On, then press the OK button.

*The live image is displayed whenever the camera is on. Press the OK button to manually turn it off and on.*

- 5 Press the Menu button to exit the menu.

*This setting remains until you change it.*

## Turning Off the Shutter Sound

- 1 Press the Menu button.
- 2 Move the joystick ▲/▼ to highlight Setup , then press the OK button.
- 3 Move the joystick to highlight Shutter Sound , then press the OK button.

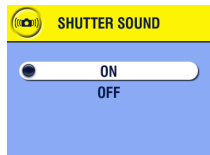

- 4 Move the joystick ▲/▼ to highlight Off, then press the OK button.

*No sound plays when a picture is taken.*

- 5 Press the Menu button to exit the menu.

*This setting remains until you change it.*

## Turning Off the Low Light Auto Focus LED

You can prevent the Low Light Auto Focus LED ([page 14](#)) from firing.

**NOTE:** When the Low Light Auto Focus LED is off, the camera may not perform as well in low light.

- 1 Press the Menu button.
- 2 Move the joystick  to highlight Setup , then press the OK button.

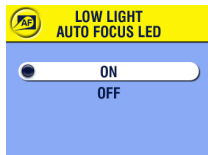

- 3 Move the joystick to highlight Low Light Auto Focus LED , then press the OK button.
- 4 Move the joystick to highlight Off, then press the OK button.
- 5 Press the Menu button to exit the menu.

*This setting remains until you change it.*

## Setting Video Out

Video Out must be set correctly to run a slide show on a television or other external device (see [page 47](#)).

- 1 Press the Menu button.
- 2 Move the joystick  to highlight Setup , then press the OK button.
- 3 Move the joystick to highlight Video Out , then press the OK button.





- 4 Move the joystick to highlight an option:
  - NTSC**—used in most countries except those in Europe and China. The United States and Japan use NTSC.
  - PAL**—used in Europe and China.
- 5 Press the OK button to accept the change.
- 6 Press the Menu button to exit the menu.

*This setting remains until you change it.*

## Selecting a Language

You can display menus and screen messages in different languages.

- 1 Press the Menu button.
- 2 Move the joystick ▲/▼ to highlight Setup , then press the OK button.
- 3 Move the joystick to highlight Language , then press the OK button.

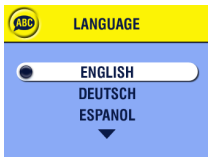

- 4 Highlight an option, then press the OK button.
- 5 Press the Menu button to exit the menu.

*Text is displayed in the selected language.  
This setting remains until you change it.*

## Formatting Internal Memory or MMC/SD Card



### CAUTION:

Formatting a card erases all pictures and videos, including protected files. Formatting internal memory erases all pictures, videos, and email addresses. (To restore addresses, see KODAK EASYSHARE Software Help.)

Removing a card during formatting may damage the card.

- 1 Press the Menu button.
- 2 Move the joystick  to highlight Setup , then press the OK button.
- 3 Move the joystick to highlight Format , then press the OK button.

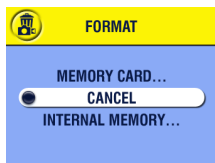

- 4 Move the joystick to highlight an option:
  - MEMORY CARD**—deletes everything on the card; formats the card.
  - CANCEL**—exits without making a change.
  - INTERNAL MEMORY**—deletes everything in internal memory; formats the internal memory.

- 5 Press the OK button.
- 6 Highlight Continue Format, then press the OK button.  
*When the formatting is complete, the Setup menu appears.*

## Viewing Camera Information

- 1 Press the Menu button.
- 2 Move the joystick ▲/▼ to highlight Setup , then press the OK button.



- 3 Move the joystick to highlight About , then press the OK button.

*The camera model and the current firmware version appear.*

- 4 Press the Menu button to exit the menu.

## Changing Advanced Digital Zoom

- 1 Press the Menu button.
- 2 Move the joystick ▲/▼ to highlight Setup , then press the OK button.

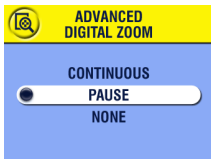

- 3 Move the joystick to highlight Advanced Digital Zoom , then press the OK button.

- 4 Move the joystick to highlight an option: **None**—disables digital zoom.

**Pause**—digital zoom turns on after the Telephoto button is pressed to the optical zoom limit, then is pressed again.

**Continuous**—digital zoom automatically turns on after the Telephoto button is pressed to the optical zoom limit and held.

- 5 Press the Menu button to exit the menu.



---

# 7 Installing the Software

## WINDOWS System Requirements

- Personal computer for WINDOWS 98, 98SE, ME, 2000, or XP
- 233 MHz processor or greater
- 64 MB of available RAM (128 MB for WINDOWS XP)
- 200 MB of available hard disk space
- CD-ROM drive
- Available USB port
- Color monitor with a minimum resolution of 800 x 600 pixels; High Color (16-bit) or True Color (24-bit) recommended
- Internet access for online printing and emailing

## MAC OS X System Requirements

- MACINTOSH computer with a G3 or G4 processor
- MAC OS 10.1.2, minimum
- 128 MB of available RAM
- 200 MB of available hard disk space
- CD-ROM drive
- Built-in USB port
- Color monitor with a minimum resolution of 800 x 600 pixels; thousands or millions of colors recommended
- Internet access for online printing and emailing

## MAC OS 8.6 and 9.x System Requirements

- POWERPC-based MACINTOSH computer
- MAC OS 8.6 or 9.x
- 64 MB of available RAM
- 200 MB of available hard disk space
- CD-ROM drive
- Built-in USB port
- Color monitor with a minimum resolution of 800 x 600 pixels; thousands or millions of colors recommended
- Internet access for online printing and emailing

NOTE: OS 8.6 and 9.x do not support the Share button functions. OS X is recommended for full functionality.



## Install the Software

For information on the software applications included on the KODAK EASYSHARE Software CD, see the Quick Start Guide or the KODAK EASYSHARE Software Help.

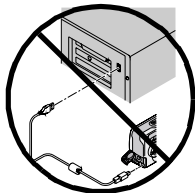

### CAUTION:

**Install the software from the KODAK EASYSHARE Software CD before connecting the camera or dock to the computer. Failure to do so may cause the software to load incorrectly.**

- 1 Before you begin, close all software applications that are open on your computer.
- 2 Place the KODAK EASYSHARE Software CD into the CD-ROM drive.
- 3 Load the software:

**WINDOWS-based computer**—if the first install window does not appear, choose Run from the Start menu and type **d:\setup.exe** where **d** is the drive letter that contains the CD.

**MAC OS 8.6 or 9.x**—on the install window, click Continue.

**MAC OS X**—double-click the CD icon on the desktop, then click the Install icon.

- 4 Follow the on-screen instructions to install the software. If prompted, restart the computer when the installation is complete.
  - Select Typical to automatically install the most commonly used applications.
  - Select Custom to choose the applications you wish to install.

NOTE: When prompted, take a few minutes to electronically register your camera and software. This lets you receive information regarding software updates and registers some of the products included with the camera. You must be connected to your Internet service provider to register electronically. To register later, see

[www.kodak.com/go/register](http://www.kodak.com/go/register).

For further installation help, see the Quick Start Guide.

---

## 8 Connecting to the Computer



### **CAUTION:**

**Install the software from the KODAK EASYSHARE Software CD before connecting the camera or Camera Dock to the computer. Failure to do so may cause the software to load incorrectly.**

You can transfer pictures and videos from the camera to the computer using either the KODAK EASYSHARE LS443 Camera Dock or the USB cable. See [page 68](#) for connecting with the USB cable.

### **Using the EASYSHARE LS443 Camera Dock**

The KODAK EASYSHARE LS443 Camera Dock makes it easy to transfer your pictures and videos to the computer.

The Camera Dock is also a rapid battery charger for the included KODAK Li-Ion Rechargeable Battery, and supplies power to the camera. To keep the battery charged, store your camera in the Camera Dock.

## Connecting the Camera Dock

After the KODAK EASYSHARE Software is loaded (see [page 63](#)), connect the Camera Dock to your computer and to an external power source. You need:

- The USB cable included with your camera
- The AC power adapter, 5V included with the Camera Dock

**IMPORTANT:** *Make sure your camera is NOT in the Camera Dock when you are connecting to power and the computer.*

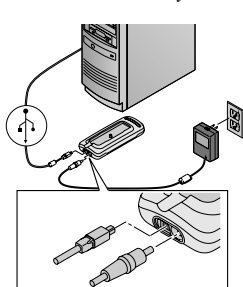

- 1 Plug the labeled  end of the USB cable into the labeled USB port on your computer. See your computer User's Guide for details.
- 2 Plug the other end of the USB cable into the square USB connector on the back of the Camera Dock.
- 3 Plug the 5V AC adapter into the round power connector on the back of the Camera Dock and into a power outlet.

**IMPORTANT:** *Use only the 5V AC adapter included with the Camera Dock. Other adapters may cause damage to your camera, Camera Dock, or computer.*

## Docking the Camera

To transfer pictures and videos from the camera to the computer, or to charge the battery:

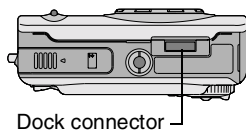

- 1 Turn **off** the camera.

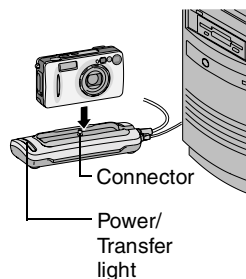

- 2 Place the camera in the Camera Dock and push down to seat the connector.

*The Power/Transfer light glows green when the camera is properly seated.*

*The camera is now powered by the Camera Dock.*

**NOTE:** If the battery requires charging, the Camera Dock immediately begins charging.

## Transferring Pictures and Videos

To transfer pictures and videos from your camera to your computer:

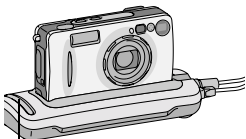

Connect button,  
Power/Transfer  
light

- 1 Place the camera in the Camera Dock. The camera can be on or off.

*If the battery is being charged, charging pauses, then resumes after pictures and videos are transferred.*

- 2 Press the Connect button.

*The Power/Transfer light blinks green while pictures and videos transfer.*

- 3 For details on printing and emailing, see the Quick Start Guide or the KODAK EASYSHARE Software Help.

**NOTE:** After transferring pictures and videos, leave the camera in the Camera Dock. Eight minutes after the transfer is complete, the Camera Dock resumes charging as necessary.

### Caution When Using a Tripod

Do not connect a tripod to the Camera Dock. Remove the camera from the Camera Dock and connect the tripod directly to the camera.

## Charging the Battery

The battery is not charged when you receive it.

- 1 Turn **off** the camera.
- 2 Make sure the battery is installed in the camera (see [page 5](#)).
- 3 Place the camera in the Camera Dock (see [page 69](#)).
  - Charging begins immediately.
  - The red light indicates charging in progress. (See [page 87](#) for other Camera Dock light information.)
  - Full charging takes about 3 hours. After the battery is fully charged, leave the camera in the Camera Dock to maintain the full charge.
  - Charging stops if you turn on the camera. If the camera is left in the Camera Dock with the power on, charging resumes when the camera enters Auto Power-off (see [page 101](#)).
  - Charging pauses if you press the Connect button on the Camera Dock. Charging resumes after pictures and videos are transferred.

**NOTE:** The Camera Dock only charges the provided KODAK EASYSHARE Li-Ion Rechargeable Battery.

## Connecting With the USB Cable

NOTE: You can use the KODAK AC adapter to power the camera; it saves battery power when transferring pictures (see [page 5](#)).

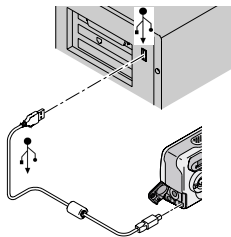

- 1 Turn off the camera.
- 2 Plug the labeled  end of the USB cable into the labeled USB port on your computer. See your computer User's Guide for details.
- 3 Plug the other end of the USB cable into the labeled USB port on the camera.

*The software prompts you through the transfer process.*

NOTE: You can also use a KODAK Multi-Card Reader or KODAK SD Multimedia Card Reader-Writer to transfer your pictures. Purchase accessories at your KODAK retail dealer or <http://www.kodak.com/go/accessories>.

## Transferring Pictures and Videos to Your Computer

For details on transferring pictures and videos, see the Quick Start Guide or the KODAK EASYSHARE Software Help.



## Printing Pictures from Your Computer

For details on printing pictures from your computer, see the Quick Start Guide or the KODAK EASYSHARE Software Help.

### Printing From an MMC/SD Card

- Automatically print tagged pictures when you insert your card into a printer with an MMC/SD slot. See your printer User's Guide for details.
- Make prints at an MMC/SD-capable KODAK Picture Maker. (We suggest contacting a location prior to visiting.)
- Take the card to your local photo retailer for professional printing.

### Ordering Prints Online

KODAK EASYSHARE Print Service (provided by Ofoto <http://www.ofoto.com>), is just one of the many great online print services offered in the KODAK EASYSHARE Software. You can easily:

- Upload your pictures.
- Edit, enhance, and add borders.
- Store pictures, and share them with family and friends.
- Order high quality prints, photo greeting cards, frames, and albums—and have them delivered to your door.



# 9 Troubleshooting

There may be times when you have questions about using your camera or Camera Dock. Additional technical information is available in the ReadMe file located on the KODAK EASYSHARE Software CD. For updates to Troubleshooting information, see <http://www.kodak.com/go/ls443support>.

## Troubleshooting—Camera

### Camera Problems

Camera		
Problem	Cause	Solution
Camera does not turn on.	Battery is not properly installed.	Reinstall the battery ( <a href="#">page 5</a> ).
	Battery is not charged.	Recharge the battery ( <a href="#">page 100</a> ).
Camera does not turn off; lens does not retract.	A non-approved battery may have been installed in the camera.	Try operating the camera with the KODAK EASYSHARE Li-Ion Rechargeable Battery.
Pictures remaining number does not decrease after taking a picture.	The picture does not take up enough space to decrease the number.	The camera is operating normally. Continue taking pictures.
Picture orientation is not accurate.	The camera was rotated or tilted while the picture was taken.	Set the Orientation Sensor ( <a href="#">page 36</a> ).

<b>Camera</b>		
<b>Problem</b>	<b>Cause</b>	<b>Solution</b>
Shutter button does not work.	Camera is not turned on.	Turn on the camera ( <a href="#">page 7</a> ).
	The camera is processing a picture; the ready light (near the viewfinder) is blinking.	Wait until the light stops blinking before attempting to take another picture.
	The card or internal memory is full.	Transfer pictures to the computer ( <a href="#">page 67</a> ), delete pictures from the camera ( <a href="#">page 43</a> ), switch storage locations ( <a href="#">page 11</a> ), or insert a card with available memory ( <a href="#">page 10</a> ).
Part of the picture is missing.	Something was blocking the lens when the picture was taken.	Keep hands, fingers, or other objects away from the lens when taking pictures.
	Your eye or the picture was not centered correctly in the viewfinder or LCD.	Leave space around subject when centering picture in viewfinder or LCD.
In Review mode, you do not see a picture (or the expected picture) on the LCD.	The camera may not be accessing the correct storage location.	Check the picture storage location setting ( <a href="#">page 11</a> ).
Stored pictures are damaged.	The card was removed when the ready light was blinking.	Make sure the ready light is not blinking before removing the card.

Camera		
Problem	Cause	Solution
Picture is too dark.	Flash is not on.	Turn on the flash (page 22).
	The subject is too far away for the flash to have an effect.	Move so there is no more than 10.8 ft (3.3 m) between the camera and the subject; 6.2 ft (1.9 m) in Telephoto.
	The subject is in front of a bright light (backlit).	Use Fill flash (page 22) or change your position so light is not behind the subject.
	Lighting is too dark.	Increase Exposure Compensation (page 27) or Long Time Exposure (page 34).
Picture is too light.	The flash is not needed.	Change to Auto flash (page 22).
	The subject was too close for flash.	Move so there is at least 1.5 ft (0.5 m) between camera and subject.
	The light sensor is covered.	Hold the camera so your hands or other objects do not cover the light sensor.
	Lighting is too bright.	Decrease exposure compensation (page 27).

<b>Camera</b>		
<b>Problem</b>	<b>Cause</b>	<b>Solution</b>
Picture is not clear.	The lens is dirty.	Clean the lens ( <a href="#">page 96</a> ).
	Subject too close when taking picture.	Move so there is at least 2.0 ft (0.6 m) between the camera and the subject, or at least 0.5 ft (15.2 cm) in Close-up mode.
	Subject or the camera moved while the picture was taken.	Hold the camera steady while taking the picture.
	The subject is too far away for the flash to be effective.	Move so there is no more than 10.8 ft (3.3 m) between the camera and the subject; 6.2 ft (1.9 m) in Telephoto.
Slide show does not run on external video device.	Video Out setting is incorrect.	Adjust the camera Video Out setting (NTSC or PAL, <a href="#">page 58</a> ).
	External device is set incorrectly.	Refer to the external device's user's guide.
Camera freezes up when a card is inserted or removed.	Camera detects an error when the card was inserted or removed.	Turn the camera off, then back on. Make sure the camera is turned off before inserting or removing a card.

## Camera/Computer Communications

Camera Communications		
Problem	Cause	Solution
The computer cannot communicate with the camera.	There is a problem with the configuration of the USB port on the computer.	See this file on the EASYSHARE Software CD: USB.html Or, go to: <a href="http://www.kodak.com/go/camerasupport">www.kodak.com/go/camerasupport</a>
	Camera power is off.	Turn on the camera (page 7).
	Battery is not charged.	Recharge the battery (page 71).
	Some Advanced Power Management utilities on laptops turn off ports to save battery life.	See the Power Management section of the laptop user's guide to disable this feature.
	USB cable is not securely connected.	Connect cable to camera and computer port (page 72).
	Software is not installed.	Install the software (page 63).
	Too many applications are running on the computer.	Disconnect camera from the computer. Close all software applications, reconnect camera.
	The Battery Monitor or similar software runs constantly.	Close that software before starting the KODAK Software.
Cannot transfer pictures. Add New Hardware Wizard cannot locate drivers.	Software is not installed.	Disconnect USB cable. (If using Camera Dock, disconnect cable and remove camera from Dock). Install EASYSHARE Software (page 63).

## MMC/SD Cards and Internal Memory

MMC/SD Cards and Internal Memory		
Problem	Cause	Solution
The camera does not recognize MMC/SD card.	The card may not be MMC/SD certified.	Purchase a certified MMC/SD card ( <a href="#">page 10</a> ).
	The card may be corrupt.	Reformat the card ( <a href="#">page 60</a> ). Caution: Formatting erases all pictures and videos, including protected files.
	Card is not fully inserted in camera.	Insert a card into the slot, then push to seat ( <a href="#">page 10</a> ).
Camera freezes up when a card is inserted or removed.	Camera detects an error when the card was inserted or removed.	Turn the camera off, then back on. Make sure the camera is off when inserting or removing a card.
Memory card full	Storage is full.	Transfer pictures and videos to the computer, then delete them from the camera.
	The maximum number of files or folders is reached (or other directory concern).	Transfer pictures and videos to the computer, then format the card or internal memory ( <a href="#">page 60</a> ). Caution: Formatting a card erases all pictures and videos, including protected files. (Formatting internal memory also erases email addresses. To restore addresses, see KODAK EASYSHARE Software Help.)



## Camera LCD Messages

LCD Messages		
Message	Cause	Solution
No images to display	There are no pictures in the current storage location.	Change picture storage location setting (page 11).
Memory card requires formatting	The card is corrupted or formatted for another digital camera.	Insert a new card or format the card (page 60).
Memory card cannot be read (Please format card or insert another card)		
Internal memory requires formatting	The camera internal memory is corrupted.	Format the internal memory (page 60).
Internal memory cannot be read (Please format internal memory)		
No memory card (Files not copied)	There is no card in the camera. Pictures were not copied.	Insert a card (page 10).
Not enough space to copy files (Files not copied)	There is not enough space in the location you are copying to (internal memory or the card).	Delete pictures from the location you are copying to (page 43), or insert a new card.
Read only card, change to internal memory to capture	The card in the camera is write-protected.	To take a picture, insert a new card or change storage location to internal memory (page 11).

LCD Messages		
Message	Cause	Solution
Card is protected (Reset switch on card)	Switch on card is in write-protect position.	Reset the switch as shown on LCD.
Card is locked (Insert a new card)	The card is write-protected.	To take a picture, insert a new card or change storage location to internal memory (page 11).
Card is unusable (Insert a new card)	The card is slow, corrupted, or unreadable.	Insert a new card (page 10).
Recording stopped. Record in internal memory (Card speed is slow)	Card cannot be used to take videos.	Change storage location to internal memory (page 11). Use card to take pictures.
Memory card is full (Cannot save Share tagging)	There is no space remaining.	Insert a new card (page 10), transfer pictures (page 67), or delete pictures (page 43).
Internal memory is full (Cannot save Share tagging)		Insert a card (page 10), transfer pictures (page 67), or delete pictures (page 43).
Date/Time entry screen appears automatically	This is the first time you turned on the camera; or the battery has been removed for an extended period of time; or the battery is exhausted.	Reset the clock (page 8).

<b>LCD Messages</b>		
<b>Message</b>	<b>Cause</b>	<b>Solution</b>
High camera temperature. (Camera will be turned off.)	The internal temperature of the camera is too high for the camera to operate. The viewfinder light glows red and the camera turns off.	Leave the camera off for several minutes, then turn it back on. If the message reappears, repeat the sequence above until the message does not appear.
Memory Card is full	There is no more space on the card in the camera.	Delete pictures from the card (page 43), insert a new card, or change storage location to internal memory (page 11).
Internal Memory is full	There is no more space in the camera's internal memory.	Delete pictures from the internal memory (page 43) or change storage location to Auto and insert card (page 10).
Unrecognized File Format	The camera cannot read the picture format.	Transfer the unreadable picture to the computer (page 67), or delete the picture (page 43).
No Address Book in Camera	No email addresses appear because there is no address book.	Create and copy address book from computer. See EASYSHARE Software Help.
Other error code	An error is detected.	Turn the Mode dial off, then back on. If error appears again, call for service.

## Camera Ready Light Status



Camera Ready Light		
Problem	Cause	Solution
Ready light does not turn on and the camera does not work.	Camera is not turned on.	Turn on the camera ( <a href="#">page 7</a> ).
	Battery is exhausted.	Recharge the battery ( <a href="#">page 71</a> ).
	Mode dial was on when battery was reloaded.	Turn Mode dial off, then back on.
Ready light glows steady green.	Camera is on; ready to take a picture or video.	The camera is operating normally.
Ready light blinks red.	Battery is low or exhausted.	Recharge the battery ( <a href="#">page 71</a> ).

<b>Camera Ready Light</b>		
<b>Problem</b>	<b>Cause</b>	<b>Solution</b>
Ready light glows steady red.	Camera's internal memory or card is full.	Transfer pictures to the computer (page 67), delete pictures from the camera (page 43), switch storage locations (page 11), or insert a card with available memory (page 10).
	Camera processing memory is full.	Wait. Resume picture taking when the light turns green.
	Card is read-only.	Change storage location to internal memory (see page 11), or use a different card.
Ready light blinks green.	Picture is being processed and saved to the camera.	Camera is operating normally.
Ready light blinks yellow.	Flash is not charged.	Wait. Resume picture taking when the light stops blinking and turns green.
	Auto exposure or auto focus are not locked.	Release the Shutter button and recompose the picture.

# Troubleshooting—Camera Dock

## Camera Dock Problems

Camera Dock		
Problem	Cause	Solution
Pictures are not transferred to the computer	AC adapter or USB cable is not securely connected.	Check the connections ( <a href="#">page 68</a> ).
	Software is not installed.	Install the software ( <a href="#">page 63</a> ).
	Too many applications running on computer.	Close all software applications and try again.
	Camera was removed from the Camera Dock during picture transfer.	Replace the camera on the Camera Dock and press the Connect button.
	Connect button was not pressed.	Press the Connect button.

## Camera Dock Light Status

Power/Transfer light

Battery charging light

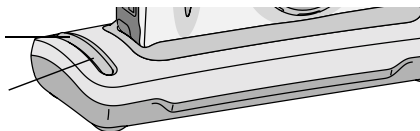

Camera Dock Lights	
Steady Green	The camera is seated in the Camera Dock, connected to AC power, and battery is not charging.
Blinking Green	Pictures and videos are being transferred to the computer.
Steady Red	The battery is charging.
Blinking Red	The battery is not properly installed. Reinstall the battery (page 5).
	The battery or connector pins are damaged. Check for damage.
	The camera and battery have been exposed to very high or low temperatures. Slowly return the camera and battery to room temperature.
No Lights	Camera is not properly seated in Camera Dock. Remove the camera and re-seat it (page 69).
	There is no power. Plug the Camera Dock into AC power. (page 68).
	The battery is not properly installed. Reinstall the battery (page 5).





# 10 Getting Help

## Helpful Web Links

Help with WINDOWS Operating System and working with digital pictures	<a href="http://www.kodak.com/go/pcbasics">www.kodak.com/go/pcbasics</a>
Help with your camera	<a href="http://www.kodak.com/go/ls443support">www.kodak.com/go/ls443support</a>
Download the latest camera software and firmware	<a href="http://www.kodak.com/go/ls443downloads">www.kodak.com/go/ls443downloads</a>
Optimize your printer for truer, more vibrant colors	<a href="http://www.kodak.com/go/onetouch">www.kodak.com/go/onetouch</a>
Get support for cameras, software, accessories, more	<a href="http://www.kodak.com/go/support">www.kodak.com/go/support</a>
Purchase camera accessories	<a href="http://www.kodak.com/go/accessories">www.kodak.com/go/accessories</a>
Register your camera	<a href="http://www.kodak.com/go/register">www.kodak.com/go/register</a>

## Help in this Manual

See [Troubleshooting, page 75](#) for help with problems you may have with your camera, camera/computer connections, Camera Dock, or MMC/SD cards.

## Software Help

Refer to the Quick Start Guide or KODAK EASYSHARE Software Help.

## Telephone Customer Support

If you have questions concerning the operation of the software or camera, you may speak with a customer support representative.

### Before You Call

Please have the camera or Camera Dock connected to your computer, be at your computer, and have the following information available:

Operating system \_\_\_\_\_

Processor speed (MHz) \_\_\_\_\_

Computer model \_\_\_\_\_

Amount of memory (MB) \_\_\_\_\_

Exact error message you received \_\_\_\_\_

Version of KODAK EASYSHARE Software CD \_\_\_\_\_

Camera serial number \_\_\_\_\_

## Telephone Numbers

Australia	1800 147 701
Austria/Osterreich	0179 567 357
Belgium/Belgique	02 713 14 45
Brazil	0800 150000
Canada	1 800 465 6325
China	800 820 6027
Denmark/Danmark	3 848 71 30
Ireland/Eire	01 407 3054
Finland/Suomi	0800 1 17056
France	01 55 1740 77
Germany/Deutschland	069 5007 0035
Greece	00800 441 25605
Hong Kong	800 901 514
India	91 22 617 5823
Italy/Italia	02 696 33452
Japan	81 3 5644 5500
Korea	00798 631 0024
Netherlands/Nederland	020 346 9372
New Zealand	0800 440 786
Norway/Norge	23 16 21 33
Philippines	1 800 1 888 9600
Portugal	021 415 4125
Singapore	800 6363 036

Spain/Espana	91 749 76 53
Sweden/Sverige	08 587 704 21
Switzerland/Schweiz/Suisse	01 838 53 51
Taiwan	00 0 861 008
Thailand	001 800 631 0017
UK	0870 243 0270
United States	1 800 235 6325
Outside the United States	585 726 7260
International Toll Line	+44 131 458 6714
International Toll Fax	+44 131 458 6962

For the most up-to-date listings, visit:

<http://www.kodak.com/US/en/digital/contacts/DAIInternationalContacts.shtml>

# 11 Appendix

## Camera Specifications

<b>KODAK EASYSHARE LS443 Zoom Digital Camera</b>		
Color		24-bit, millions of colors
Communication with computer	USB	Via Camera Dock or USB cable
Dimensions	Width	4.3 in. (109 mm)
	Depth	1.5 in. (37.5 mm)
	Height	2.4 in. (61.5 mm)
	Weight	8.6 oz (245 g) with battery and card
Exposure control		Multi-pattern/Center weighted TTL-AE with program modes (Standard, Sport, Night, Long Time)
Flash	Modes	Auto, Fill, Red-eye, Off
	Range	Wide: 1.5 to 10.8 ft (0.5 to 3.3 m) Tele: 1.5 to 6.2 ft (0.5 to 1.9 m)
	Charging Time	Less than 7 seconds with charged battery
ISO		Automatic (100 to 200) Manual (100, 200, 400) Video (100 to 400)
LCD		1.8 in. (45.7 mm), color, 72,000 pixels Preview rate: 19.5 fps

<b>KODAK EASYSHARE LS443 Zoom Digital Camera</b>		
Lens	Type	Optical quality glass, 6 groups/7 elements (4 aspherical lenses)
	Maximum Aperture	f/2.8 - f/9.6
	Focal Length	35 - 105 mm
	Focus Distance	Close-up: 6 to 27.5 in. (13 to 70 cm) Standard: 2 ft (0.6 m) to infinity Landscape: Fixed focus
Operating Temperature		32 to 104 <sup>o</sup> F (0 to 40 <sup>o</sup> C)
File format	Still	JPEG/EXIF v2.2 <b>Exif Print</b>
	Video	QUICKTIME movie
Picture storage		16 MB internal; SD Card or MMC
Pixel resolution	★★★	Best: 2448 x 1632 (4.0 M) pixels
	★★	Better: 1800 x 1200 (2.2 M) pixels
	★	Good: 1224 x 816 (1 M) pixels
Video resolution		309 x 206 pixels, 15 fps
Power	Battery	Li-Ion Rechargeable 3.7V, 1050mAh
	AC adapter	5V DC
Self Timer		10 seconds
Tripod socket		Yes
Video Out		NTSC or PAL selectable
Viewfinder		Real image optical
White balance		Auto, Daylight, Tungsten, Fluorescent
Zoom (still capture)		3X optical, 3.3X digital

## Original Factory Settings—Camera

Feature	Factory Setting
Date/Time	2002/1/1; 12:00
Date/Time Stamp	Off
Default Print Quantity	1
Digital Zoom initiation	Pause
Exposure Metering Mode	Multi-patterned
Flash	<b>Auto:</b> Auto or Red-eye <b>Sport, Night:</b> Auto <b>Landscape, Close-up, Video:</b> Flash Off
Focus Zone	Multi-zone
Language	English
Liveview	Off
Orientation Sensor	On
Picture/Video Storage Location	Auto
Picture Quality	Best
Quickview	On
Shutter Sound	On
Slide Show Interval	5 seconds
Slide Show Loop	Off
Video Date Display	None
Video Out	NTSC

## Upgrading Your Software and Firmware

Download the latest versions of the software included on the KODAK EASYSHARE Software CD and the camera firmware (the software that runs on the camera). See <http://www.kodak.com/go/ls443downloads>.

## Tips, Safety, Maintenance

- Always follow basic safety precautions. Refer to the “Important Safety Instructions” booklet packed with your camera.
- Do not allow any chemicals, such as suntan lotion, to come into contact with the painted surface of the camera.
- If the camera has been subjected to inclement weather or you suspect water has gotten inside the camera, turn off the camera and remove the battery and card. Allow all components to air-dry for at least 24 hours before using the camera again.
- Clean the lens and back LCD:
  - 1 Blow gently on the lens or LCD to remove dust and dirt.
  - 2 Moisten the lens or LCD by breathing lightly on it.
  - 3 Wipe the lens or LCD gently with a soft, lint-free cloth or an untreated lens-cleaning tissue.
- Do not use cleaning solutions unless they are designed specifically for camera lenses. **Do not wipe the camera lens or LCD with chemically treated eyeglass lens tissue. It may scratch the lens.**
- Wipe the outside of the camera with a clean, dry cloth. Never use harsh or abrasive cleaners or organic solvents on the camera or any of its parts.
- Service agreements are available in some countries. Contact a dealer of Kodak products for more information.
- For digital camera disposal or recycling information, please contact your local authorities. In the US, visit the Electronics Industry Alliance Web site at [www.eiae.org](http://www.eiae.org) or the Kodak Web site at [www.kodak.com/go/ls443support](http://www.kodak.com/go/ls443support).



## Storage Capacities

File sizes can vary. You may be able to store more or fewer pictures and videos. Purchase accessories at your KODAK retail dealer or <http://www.kodak.com/go/accessories>.

### Picture Storage Capacity

	Number of pictures		
	Best Quality ★★★	Better Quality ★★	Good Quality ★
<b>16 MB internal memory</b>	12	22	46
<b>16 MB MMC/SD</b>	12	22	46
<b>32 MB MMC/SD</b>	25	46	93
<b>64 MB MMC/SD</b>	51	92	187
<b>128 MB MMC/SD</b>	102	185	375
<b>192 MB MMC/SD</b>	154	278	562

### Video Storage Capacity

	Minutes/seconds of video
<b>16 MB internal memory</b>	1 min. 10 sec.
<b>16 MB MMC/SD</b>	1 min. 10 sec.
<b>32 MB MMC/SD</b>	2 min. 20 sec.
<b>64 MB MMC/SD</b>	4 min. 40 sec.
<b>128 MB MMC/SD</b>	9 min. 20 sec.
<b>192 MB MMC/SD</b>	14 min.

## Locating Pictures and Videos on a Card

Pictures stored on MMC/SD Cards use a standard agreed upon by many camera manufacturers. This lets you use the cards in different cameras. If you use a card reader to retrieve your files, the following description of the card file structure may be helpful.

**MISC folder**—contains the order files created when you use the Share feature to tag files for printing, emailing, and as favorites.

**SYSTEM folder**—used for updating camera firmware.

**DCIM folder**—root level folder, contains the 100K443 folder. Each time you turn on the camera or insert a different card, any empty folders within the DCIM folder are removed.

**100K443 subfolder**—initially contains all pictures and videos on the card.

## Card File Naming Conventions

- Pictures are named 100\_nnnn.JPG, and are numbered in the order in which they are taken. The first picture is named 100\_0001.JPG; the highest number allowed is 100\_9999.JPG.
- When a card contains a picture named 100\_9999.JPG in the \DCIM\100K443 folder, subsequent pictures appear in a new folder (\DCIM\101K443), beginning with picture 101\_0001.JPG.
- Even if you transfer pictures to the computer or delete pictures from the camera, the camera continues to use consecutive numbers for all subsequent pictures. For example, if the last picture taken was 100\_0007.JPG and you delete it, the next picture you take is named 100\_0008.JPG.
- When you insert a different card into your camera, the next picture number is defined by incrementing the higher of the last picture taken by the camera, or the highest existing picture number in the folder.

- If you use the card in a camera other than the KODAK EASYSHARE LS443 Zoom Digital Camera, and that camera manufacturer adheres to this file structure standard, the \DCIM folder contains a folder named by that camera. For more information, refer to the documentation that accompanied that camera.

## Burst Pictures

When a burst series is initiated, a letter “B” replaces the underscore in the file name. When a burst series is initiated or ended, the second digit to the left of the decimal is incremented by 1.

Image	Mode	File name
1	Still	100_0001.JPG
2	Still	100_0002.JPG
3	Burst(1/3)	100B0010.JPG
4	Burst(2/3)	100B0011.JPG
5	Burst(3/3)	100B0012.JPG
6	Burst(1/2)	100B0020.JPG
7	Burst(2/2)	100B0021.JPG
8	Still	100_0030.JPG
9	Still	100_0031.JPG

## Using the Battery

- We recommend using only a KODAK EASYSHARE Li-Ion Rechargeable Battery or equivalent 3.7V Li-Ion. Not all manufacturer's 3.7V Li-Ion rechargeable batteries are compatible with the camera. Damage caused by unauthorized accessories is not covered under warranty. Purchase accessories at your KODAK retail dealer or <http://www.kodak.com/go/accessories>.
- For acceptable battery life, and to make sure your camera operates dependably, **we do not recommend or support other batteries.**
- **To lengthen battery life**, limit the following activities:
  - Using Liveview (using the LCD as the viewfinder, see [page 18](#))
  - Reviewing your pictures on the LCD (see [page 41](#))
  - Excessive use of the flash
- Dirt on the battery contacts can affect battery life. Wipe the contacts with a clean, dry cloth before loading batteries in the camera.
- Battery life depends significantly on battery age, usage conditions, type, and brand. Digital camera requirements are very demanding on batteries. Not all batteries perform well under these challenging conditions.
- Battery performance is reduced at temperatures below 41° F (5° C). Carry spare batteries when using your camera in cold weather, and keep them warm until you are ready to take pictures. Do not discard cold batteries that do not work. When they return to room temperature, they may be usable.
- Do not allow batteries to touch metal objects, including coins. Otherwise, a battery may short circuit, discharge energy, become hot, or leak.

## Expected Battery Life

Battery Type	Pictures per Full Battery Charge (Approximate)*
KODAK EASYSHARE Li-Ion Rechargeable Battery	200-300

\* Actual battery life may vary based on usage.

## Power-Saving Features

If No Activity For	The	To Turn It Back On
1 minute	LCD turns off.	Press the OK button.
8 minutes	Camera enters auto power off. Flash, self-timer, burst, exposure compensation, white balance, ISO, color mode, and long time exposure return to the default setting.	Press any button (or insert or remove a card).
1 hour	Camera turns off.	Turn Mode dial Off, then back on.

## Regulatory Information

### FCC Compliance and Advisory

This device complies with Part 15 of the FCC Rules. Operation is subject to the following two conditions: 1) this device may not cause harmful interference, and 2) this device must accept any interference received, including interference that may cause undesired operation.

This equipment has been tested and found to comply with the limits for a Class B digital device, pursuant to Part 15 of the FCC Rules. These limits are designed to provide reasonable protection against harmful interference in a residential installation.

This equipment generates, uses, and can radiate radio frequency energy and, if not installed or used in accordance with the instructions, may cause harmful interference to radio communications. However, there is no guarantee that interference will not occur in a particular installation.

If this equipment does cause harmful interference to radio or television reception, which can be determined by turning the equipment off and on, the user is encouraged to try to correct the interference by one or more of the following measures: 1) reorient or relocate the receiving antenna; 2) increase the separation between the equipment and the receiver; 3) connect the equipment to an outlet on a circuit different from that to which the receiver is connected; 4) consult the dealer or an experienced radio/TV technician for additional suggestions.

Any changes or modifications not expressly approved by the party responsible for compliance could void the user's authority to operate the equipment. Where shielded interface cables have been provided with the product or specified additional components or accessories elsewhere defined to be used with the installation of the product, they must be used in order to ensure compliance with FCC regulation.

### **Canadian DOC Statement**

**DOC Class B Compliance**—This Class B digital apparatus complies with Canadian ICES-003.

**Observation des normes-Class B**—Cet appareil numérique de la classe B est conforme à la norme NMB-003 du Canada.

## A

### about

- camera information, 61
- picture, video, 49

### AC adapter, 5

### accessories, buying, 89

### adjusting

- exposure compensation, 27
- picture quality, 29

### advanced digital zoom, 61

### arrow buttons, ii

### auto

- flash, 22
- focus framing marks, 20
- focus LED, 14, 58
- power-down, 101

## B

### batteries

- charging Battery Pack, 71
- extending battery life, 100
- power level, 9
- replacement, 100
- tips, 100

### battery

- loading, 5

### burst series, 25

### button

- arrow, ii
- delete, 19
- flash, 22
- menu, 11
- OK, 7
- review, 41
- share, 51
- shutter, 13
- zoom, 21

## C

### cable

- audio/video, 3, 47
- USB, 3, 72

### Camera Dock

- charging Battery Pack, 71
- charging lights, 71
- docking camera, 69
- lights status, 87
- power connection, 68

- transferring pictures, 70
  - USB connection, 68
  - using, 67
  - Canadian compliance, 102
  - card, memory, 98
  - caring for your camera, 96
  - changing picture, video
    - location, 11
  - charging Battery Pack, 71
  - charging lights, Camera Dock, 71
  - checking location setting, 12
  - checking picture location, 12
  - cleaning camera, lens, 96
  - clock, setting, 8
  - color mode, 30
  - communication problems, 79
  - computer
    - connecting Camera Dock, 68
    - system requirements, 63
    - transferring pictures, 72
    - transferring to, 67
  - connecting Camera Dock, 68
  - copy pictures
    - card to memory, 48
    - memory to card, 48
    - to computer, 67
  - copy to computer, 70
  - customer support numbers, 90
  - customizing camera settings, 55
- D**
- date
    - imprinting on pictures, 35
    - setting, 8
  - DCIM folder, card, 98
  - defaults
    - changing print quantity, 56
    - original settings, 95
  - deleting
    - by formatting, 60
    - during quickview, 38
    - from internal memory, 43
    - from MMC/SD Card, 43
    - last picture, 19
    - last video, 38
    - protecting pictures, videos, 45
  - digital pictures, using, 72
  - digital zoom, 21, 61
  - display problems, 76
  - displaying slide show, 46
  - disposal, recycling, 96
  - docking camera, 69
  - downloading
    - pictures, 67, 70, 72



**E**

- EASYSHARE Software,
  - installing, 63
- emailing pictures, videos, 53
- error messages, 81
- exposure
  - compensation, 27
  - long time, 34
- exposure metering, 31
- external video device
  - setting video out, 58
  - viewing pictures, videos, 47

**F**

- favorites, tagging for, 54
- FCC compliance, 101
- file names, card, 98
- firmware
  - upgrading, 96
  - version, 61
- flash
  - auto, 22
  - fill, 22
  - red-eye, 22
  - using, 22
- focus
  - framing marks, 20
  - low light LED, 14, 58
  - zone, 32

- folders, card, 98
- formatting
  - internal memory, 60
  - MMC/SD card, 60

**G**

- guidelines, battery, 100

**H**

- help
  - camera, 75
  - Camera Dock, 86
  - software, 89
  - telephone support, 90
  - web links, 89

**I**

- icons
  - camera status, 9
  - mode dial, 6
- image storage menu, 11
- information
  - about camera, 61
  - about pictures, videos, 49
- installing
  - battery, 5
  - MMC/SD card, 10
  - software, 65
- internal memory

- formatting, 60
- setting picture, video
  - location, 11
- storage capacity, 97

ISO speed, 33

**K**

**KODAK EASYSHARE Software**

- getting help, 89
- installing, 65
- transferring pictures, 72
- upgrading, 96

Kodak web sites, 89

**L**

language, setting, 59

**LCD**

- displaying languages, 59
- error messages, 81
- picture location icon, 9
- reviewing last picture, 19
- reviewing last video, 38
- status bar, 9
- turning off quickview, 56
- turning on liveview, 57
- using as viewfinder, 18
- viewing pictures on, 42

LED, low light focus, 14, 58

lens

accessory, 12

cleaning, 96

**light**

charging, 71

ready, camera, 84

self-timer, camera, 24, 40

**liveview**

turning on, 57

using LCD as viewfinder, 18

**loading**

MMC/SD card, 10

software, 65

long time exposure, 34

**M****MACINTOSH**

installing software on, 65

system requirements, 64

magnify picture, 44

maintenance, camera, 96

**memory**

internal or card, 11

storage location setting, 11

**memory card**

inserting, 10

storage capacities, 97

menu button, 11

MISC folder, card, 98

MMC/SD card

- file name conventions, 98
- formatting, 60
- inserting, 10
- printing from, 73
- problems, 80
- setting picture, video
  - location, 11
  - storage capacities, 97
- mode dial, 6
- monitor, requirements, 63
  
- N**
- NTSC, video out setting, 58
  
- O**
- OK button, 7
- online prints, ordering, 73
- optical zoom, 21
- orientation sensor, 36
- overview, camera, ii
- overview, camera modes, 6
  
- P**
- package contents
  - camera, 3
- PAL, video out setting, 58
- pictures
  - checking location, 12
  - copying, 48
  - date imprint, 35
  - deleting, 43
  - downloading, 72
  - emailing tagged, 53
  - file naming, 98
  - locating on card, 98
  - magnifying, 44
  - printing, 73
  - printing tagged, 52
  - protecting, 45
  - quality, setting, 29
  - reviewing, 41
  - storage capacity, 97
  - taking, 13
  - transferring to
    - computer, 67, 70
    - using on computer, 72
  - viewing, 42
- power
  - camera dock, 68
  - turning camera on, 7
- power-down, auto, 101
- printing
  - changing default quantity, 56
  - from a card, 73
  - optimizing printer, 89
  - pictures, 73
  - tagged pictures, 73
  - this user guide, 1

product overview, ii  
protecting pictures, videos, 45

## Q

quality

print, digital zoom, 21  
setting, 29

quickview, 38  
turning off, 56  
using, 19, 38

## R

ReadMe file, 75

ready light

camera, 13  
Camera Dock, 84

recycling, disposal, 96  
red-eye, flash, 22  
regulatory information, 101  
removable memory card, 10  
replacement batteries, 100  
requirements  
  MACINTOSH, 64  
  WINDOWS-based, 63  
resolution, setting, 29  
review button, 41  
review mode, using, 41  
reviewing pictures  
  as you take them, 19

deleting, 43  
magnify, 44  
on LCD, 42  
protecting, 45  
slide show, 46

reviewing videos  
  as you take them, 38  
  deleting, 43  
  on LCD, 42  
  protecting, 45  
  slide show, 46  
running slide show, 46

## S

safety, 96  
SD card, inserting, 10  
self-timer  
  pictures, 24  
  videos, 40  
service and support  
  telephone numbers, 90  
setting  
  date and time, 8  
  flash, 22  
  language, 59  
  mode dial menus, 6  
  picture quality, 29  
  picture, video storage  
    location, 11

- resolution, 29
  - self-timer, 24, 40
  - video out, 58
  - setup mode, using, 55
  - share button, 51
  - shutoff, auto, 101
  - shutter
    - problems, 76
    - self-timer delay, 24, 40
    - sounds, 57
    - taking pictures, 13
  - sleep mode, 101
  - slide show
    - continuous loop, 47
    - problems, 78
    - running, 46
  - software
    - getting help, 89
    - installing, 65
    - transferring pictures, 72
    - upgrading, 96
  - sounds, shutter, 57
  - specifications
    - camera, 93
    - MACINTOSH, 64
    - WINDOWS-based, 63
  - status
    - bar, 9
    - picture storage location, 12
    - screen icons, 9
    - storage capacity, memory, 97
    - strap, wrist, 4
    - support, technical, 90
    - System folder, card, 98
    - system requirements
      - MACINTOSH, 64
      - WINDOWS, 63
- T**
- tagging
    - for email, 53
    - for favorites, 54
    - for print, 52
    - when to tag, 51
  - taking pictures, 13
  - taking videos, 37
  - telephone support, 90
  - television, slide show, 47
  - time, setting, 8
  - timer, shutter delay, 24, 40
  - tips
    - battery guidelines, 100
    - maintenance, 96
    - ReadMe file, 75
    - safety, 96
  - transferring to
    - computer, 67, 70, 72
  - trash can, deleting, 19, 38

- troubleshooting
  - camera, 75
  - camera communications, 79
  - Camera Dock, 86
  - camera ready light, 84
  - LCD messages, 81
  - MMC/SD card, 80
- turning camera on and off, 7
- U**
  - upgrading software,
    - firmware, 96
  - URLs, Kodak web sites, 89
- V**
  - video mode, using, 37
  - video out, setting, 58
  - videos
    - checking location, 12
    - copying, 48
    - date display, 49
    - deleting, 43
    - emailing tagged, 53
    - file naming, 98
    - protecting, 45
    - reviewing, 41
    - storage capacities, 97
    - taking, 37
    - transferring to
      - computer, 67, 70
      - using on computer, 72
      - viewing, 42
  - viewfinder
    - using LCD, 18
  - viewing
    - camera information, 61
    - picture, video
      - information, 49
  - viewing picture
    - after taking, 19, 42
    - from internal memory, 42
    - magnified, 44
    - on MMC/SD Card, 42
  - viewing video, after taking, 38
- W**
  - white balance, 28
  - WINDOWS
    - installing software, 65
    - system requirements, 63
  - wrist strap, 4
- Z**
  - zoom
    - changing digital, 61
    - digital, 21
    - optical, 21